



OWNER'S MANUAL

**⚠ Read this manual carefully  
before operating this vehicle.**



MOTORCYCLE

**YZF690**

Location of important labels	<b>1</b>
Safety information	<b>2</b>
Description	<b>3</b>
Instrument and control functions	<b>4</b>
For your safety – pre-operation checks	<b>5</b>
Operation and important riding points	<b>6</b>
Periodic maintenance and adjustment	<b>7</b>
Motorcycle care and storage	<b>8</b>
Specifications	<b>9</b>
Consumer information	<b>10</b>
Index	<b>11</b>



เครื่องวิทยุคมนาคมนี้ ได้รับยกเว้น ไม่ต้องได้รับ  
ใบอนุญาตให้มี ใช้ซึ่งเครื่องวิทยุคมนาคม  
หรือตั้งสถานีวิทยุคมนาคมตามประกาศ กสทช.  
เรื่อง เครื่องวิทยุคมนาคม และสถานีวิทยุ  
คมนาคมที่ได้รับยกเว้นไม่ต้องได้รับใบอนุญาต  
วิทยุคมนาคม ตามพระราชบัญญัติวิทยุ  
คมนาคม พ.ศ. 2498



**nab.** | โทรคมนาคม  
กำกับดูแลเพื่อประชาชน  
Call Center 1200 (Inswr)

เครื่องโทรคมนาคมและอุปกรณ์นี้ มีความสอดคล้องตาม  
มาตรฐานหรือข้อกำหนดทางเทคนิคของ กสทช.

 **Read this manual carefully before operating this vehicle. This manual should stay with this vehicle if it is sold.**

Welcome to the Yamaha world of motorcycling!

As the owner of the YZF690, you are benefiting from Yamaha's vast experience and newest technology regarding the design and manufacture of high-quality products, which have earned Yamaha a reputation for dependability.

Please take the time to read this manual thoroughly, so as to enjoy all advantages of your YZF690. The Owner's Manual does not only instruct you in how to operate, inspect and maintain your motorcycle, but also in how to safeguard yourself and others from trouble and injury.

In addition, the many tips given in this manual will help keep your motorcycle in the best possible condition. If you have any further questions, do not hesitate to contact your Yamaha dealer.

The Yamaha team wishes you many safe and pleasant rides. So, remember to put safety first!

Yamaha continually seeks advancements in product design and quality. Therefore, while this manual contains the most current product information available at the time of printing, there may be minor discrepancies between your motorcycle and this manual. If there is any question concerning this manual, please consult a Yamaha dealer.



---

**Please read this manual carefully and completely before operating this motorcycle.**



---

# Important manual information

---

EAU10134

Particularly important information is distinguished in this manual by the following notations:

	<b>This is the safety alert symbol. It is used to alert you to potential personal injury hazards. Obey all safety messages that follow this symbol to avoid possible injury or death.</b>
 <b>WARNING</b>	<b>A WARNING indicates a hazardous situation which, if not avoided, could result in death or serious injury.</b>
<b>NOTICE</b>	<b>A NOTICE indicates special precautions that must be taken to avoid damage to the vehicle or other property.</b>
<b>TIP</b>	A TIP provides key information to make procedures easier or clearer.

\*Product and specifications are subject to change without notice.

EAU10202

**YZF690  
OWNER'S MANUAL  
©2024 by Yamaha Motor Co., Ltd.  
1st edition, August 2023  
All rights reserved.  
Any reprinting or unauthorized use  
without the written permission of  
Yamaha Motor Co., Ltd.  
is expressly prohibited.  
Printed in Japan.**

# Table of contents

---

<b>Location of important labels</b> .....	1-1	DC connectors .....	4-25	Checking the engine idling speed .....	7-16
<b>Safety information</b> .....	2-1	Sidestand .....	4-25	Checking the throttle grip free play.....	7-17
Helmets .....	2-5	Ignition circuit cut-off system .....	4-26	Valve clearance.....	7-17
<b>Description</b> .....	3-1	<b>For your safety – pre-operation checks</b> .....	5-1	Tires .....	7-17
Left view .....	3-1	<b>Operation and important riding points</b> .....	6-1	Cast wheels .....	7-20
Right view .....	3-2	Engine break-in .....	6-1	Adjusting the clutch lever free play.....	7-20
Controls and instruments .....	3-3	Starting the engine.....	6-2	Checking the brake lever free play.....	7-21
<b>Instrument and control functions</b> ...	4-1	Shifting .....	6-3	Brake light switches .....	7-21
Immobilizer system.....	4-1	Tips for reducing fuel consumption.....	6-4	Checking the front and rear brake pads .....	7-22
Main switch/steering lock.....	4-2	Parking .....	6-5	Checking the brake fluid level .....	7-22
Indicator lights and warning lights.....	4-3	<b>Periodic maintenance and adjustment</b> .....	7-1	Changing the brake fluid .....	7-24
Multi-function meter unit .....	4-5	Tool kits.....	7-2	Drive chain slack.....	7-24
Handlebar switches.....	4-11	Periodic maintenance chart for the emission control system.....	7-3	Cleaning and lubricating the drive chain .....	7-26
Clutch lever .....	4-13	General maintenance and lubrication chart.....	7-5	Checking and lubricating the cables.....	7-26
Shift pedal .....	4-13	Removing and installing cowlings... ..	7-9	Checking and lubricating the throttle grip and cable .....	7-27
Brake lever.....	4-14	Checking the spark plugs .....	7-10	Checking and lubricating the brake and shift pedals.....	7-27
Brake pedal .....	4-14	Canister.....	7-11	Checking and lubricating the brake and clutch levers.....	7-28
ABS .....	4-14	Engine oil and oil filter cartridge....	7-11	Checking and lubricating the sidestand.....	7-28
Fuel tank cap.....	4-15	Why Yamalube .....	7-14	Lubricating the rear suspension ...	7-29
Fuel.....	4-16	Coolant.....	7-14		
Fuel tank overflow hose .....	4-17	Replacing the air filter element and cleaning the check hose.....	7-16		
Catalytic converter .....	4-18				
Seats .....	4-18				
Rear view mirrors.....	4-20				
Adjusting the front fork.....	4-21				
Adjusting the shock absorber assembly.....	4-23				

# Table of contents

---

Lubricating the swingarm	
pivots .....	7-29
Checking the front fork.....	7-29
Checking the steering .....	7-30
Checking the wheel bearings .....	7-30
Battery .....	7-31
Replacing the fuses.....	7-32
Vehicle lights .....	7-33
Replacing a license plate light	
bulb .....	7-34
Supporting the motorcycle.....	7-34
Troubleshooting .....	7-35
Troubleshooting chart .....	7-36
<b>Motorcycle care and storage .....</b>	<b>8-1</b>
Matte color caution .....	8-1
Care.....	8-1
Storage.....	8-4
<b>Specifications.....</b>	<b>9-1</b>
<b>Consumer information .....</b>	<b>10-1</b>
Identification numbers.....	10-1
Diagnostic connector .....	10-2
Use of your data.....	10-3
<b>Index .....</b>	<b>11-1</b>

# Location of important labels

EAU10387

1

Read and understand all of the labels on your vehicle. They contain important information for safe and proper operation of your vehicle. Never remove any labels from your vehicle. If a label becomes difficult to read or comes off, a replacement label is available from your Yamaha dealer.

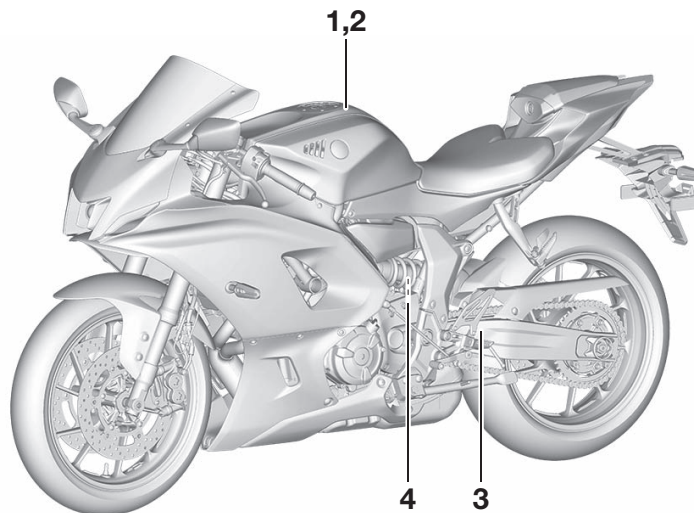



# Location of important labels

1



2



3

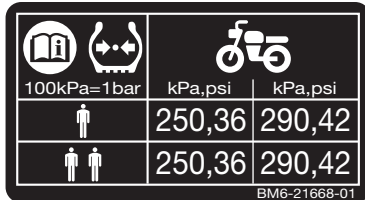

4



1

## 2 Be a Responsible Owner

As the vehicle's owner, you are responsible for the safe and proper operation of your motorcycle.

Motorcycles are single-track vehicles. Their safe use and operation are dependent upon the use of proper riding techniques as well as the expertise of the operator. Every operator should know the following requirements before riding this motorcycle.

He or she should:

- Obtain thorough instructions from a competent source on all aspects of motorcycle operation.
- Observe the warnings and maintenance requirements in this Owner's Manual.
- Obtain qualified training in safe and proper riding techniques.
- Obtain professional technical service as indicated in this Owner's Manual and/or when made necessary by mechanical conditions.

- Never operate a motorcycle without proper training or instruction. Take a training course. Beginners should receive training from a certified instructor. Contact an authorized motorcycle dealer to find out about the training courses nearest you.

### Safe Riding

Perform the pre-operation checks each time you use the vehicle to make sure it is in safe operating condition. Failure to inspect or maintain the vehicle properly increases the possibility of an accident or equipment damage. See page 5-1 for a list of pre-operation checks.

- This motorcycle is designed to carry the operator and a passenger.
- The failure of motorists to detect and recognize motorcycles in traffic is the predominating cause of automobile/motorcycle accidents. Many accidents have been caused by an automobile driver who did not see the motorcycle. Making yourself conspicuous ap-

pears to be very effective in reducing the chance of this type of accident.

### Therefore:

- Wear a brightly colored jacket.
- Use extra caution when you are approaching and passing through intersections, since intersections are the most likely places for motorcycle accidents to occur.
- Ride where other motorists can see you. Avoid riding in another motorist's blind spot.
- Never maintain a motorcycle without proper knowledge. Contact an authorized motorcycle dealer to inform you on basic motorcycle maintenance. Certain maintenance can only be carried out by certified staff.

- Many accidents involve inexperienced operators. In fact, many operators who have been involved in accidents do not even have a current motorcycle license.
  - Make sure that you are qualified and that you only lend your motorcycle to other qualified operators.
  - Know your skills and limits. Staying within your limits may help you to avoid an accident.
  - We recommend that you practice riding your motorcycle where there is no traffic until you have become thoroughly familiar with the motorcycle and all of its controls.
- Many accidents have been caused by error of the motorcycle operator. A typical error made by the operator is veering wide on a turn due to excessive speed or undercornering (insufficient lean angle for the speed).
  - Always obey the speed limit and never travel faster than warranted by road and traffic conditions.
- Always signal before turning or changing lanes. Make sure that other motorists can see you.
- The posture of the operator and passenger is important for proper control.
  - The operator should keep both hands on the handlebar and both feet on the operator footrests during operation to maintain control of the motorcycle.
  - The passenger should always hold onto the operator, the seat strap or grab bar, if equipped, with both hands and keep both feet on the passenger footrests. Never carry a passenger unless he or she can firmly place both feet on the passenger footrests.
- Never ride under the influence of alcohol or other drugs.
- This motorcycle is designed for on-road use only. It is not suitable for off-road use.

### **Protective Apparel**

The majority of fatalities from motorcycle accidents are the result of head injuries. The use of a safety helmet is the single most critical factor in the prevention or reduction of head injuries.

- Always wear an approved helmet.
- Wear a face shield or goggles. Wind in your unprotected eyes could contribute to an impairment of vision that could delay seeing a hazard.
- The use of a jacket, heavy boots, trousers, gloves, etc., is effective in preventing or reducing abrasions or lacerations.
- Never wear loose-fitting clothes, otherwise they could catch on the control levers, footrests, or wheels and cause injury or an accident.
- Always wear protective clothing that covers your legs, ankles, and feet. The engine or exhaust system become very hot during or after operation and can cause burns.
- A passenger should also observe the above precautions.

## Safety information

2

### **Avoid Carbon Monoxide Poisoning**

All engine exhaust contains carbon monoxide, a deadly gas. Breathing carbon monoxide can cause headaches, dizziness, drowsiness, nausea, confusion, and eventually death.

Carbon Monoxide is a colorless, odorless, tasteless gas which may be present even if you do not see or smell any engine exhaust. Deadly levels of carbon monoxide can collect rapidly and you can quickly be overcome and unable to save yourself. Also, deadly levels of carbon monoxide can linger for hours or days in enclosed or poorly ventilated areas. If you experience any symptoms of carbon monoxide poisoning, leave the area immediately, get fresh air, and **SEEK MEDICAL TREATMENT.**

- Do not run engine indoors. Even if you try to ventilate engine exhaust with fans or open windows and doors, carbon monoxide can rapidly reach dangerous levels.
- Do not run engine in poorly ventilated or partially enclosed areas such as barns, garages, or carports.

- Do not run engine outdoors where engine exhaust can be drawn into a building through openings such as windows and doors.

### **Loading**

Adding accessories or cargo to your motorcycle can adversely affect stability and handling if the weight distribution of the motorcycle is changed. To avoid the possibility of an accident, use extreme caution when adding cargo or accessories to your motorcycle. Use extra care when riding a motorcycle that has added cargo or accessories. Here, along with the information about accessories below, are some general guidelines to follow if loading cargo to your motorcycle:

The total weight of the operator, passenger, accessories and cargo must not exceed the maximum load limit.

**Operation of an overloaded vehicle could cause an accident.**

**Maximum load:**  
162 kg (357 lb)

When loading within this weight limit, keep the following in mind:

- Cargo and accessory weight should be kept as low and close to the motorcycle as possible. Securely pack your heaviest items as close to the center of the vehicle as possible and make sure to distribute the weight as evenly as possible on both sides of the motorcycle to minimize imbalance or instability.
- Shifting weights can create a sudden imbalance. Make sure that accessories and cargo are securely attached to the motorcycle before riding. Check accessory mounts and cargo restraints frequently.
- Properly adjust the suspension for your load (suspension-adjustable models only), and check the condition and pressure of your tires.
- Never attach any large or heavy items to the handlebar, front fork, or front fender. These items, including such cargo as sleeping bags, duffel bags, or

tents, can create unstable handling or a slow steering response.

- **This vehicle is not designed to pull a trailer or to be attached to a sidecar.**

### **Genuine Yamaha Accessories**

Choosing accessories for your vehicle is an important decision. Genuine Yamaha accessories, which are available only from a Yamaha dealer, have been designed, tested, and approved by Yamaha for use on your vehicle.

Many companies with no connection to Yamaha manufacture parts and accessories or offer other modifications for Yamaha vehicles. Yamaha is not in a position to test the products that these aftermarket companies produce. Therefore, Yamaha can neither endorse nor recommend the use of accessories not sold by Yamaha or modifications not specifically recommended by Yamaha, even if sold and installed by a Yamaha dealer.

### **Aftermarket Parts, Accessories, and Modifications**

While you may find aftermarket products similar in design and quality to genuine Yamaha accessories, recognize that some aftermarket accessories or modifications are not suitable because of potential safety hazards to you or others. Installing aftermarket products or having other modifications performed to your vehicle that change any of the vehicle's design or operation characteristics can put you and others at greater risk of serious injury or death. You are responsible for injuries related to changes in the vehicle.

Keep the following guidelines in mind, as well as those provided under "Loading" when mounting accessories.

- Never install accessories or carry cargo that would impair the performance of your motorcycle. Carefully inspect the accessory before using it to make sure that it does not in any way reduce ground clearance or cornering clearance, limit suspension travel,

steering travel or control operation, or obscure lights or reflectors.

- Accessories fitted to the handlebar or the front fork area can create instability due to improper weight distribution or aerodynamic changes. If accessories are added to the handlebar or front fork area, they must be as lightweight as possible and should be kept to a minimum.
- Bulky or large accessories may seriously affect the stability of the motorcycle due to aerodynamic effects. Wind may attempt to lift the motorcycle, or the motorcycle may become unstable in cross winds. These accessories may also cause instability when passing or being passed by large vehicles.
- Certain accessories can displace the operator from his or her normal riding position. This improper position limits the freedom of movement of the

## Safety information

2

operator and may limit control ability, therefore, such accessories are not recommended.

- Use caution when adding electrical accessories. If electrical accessories exceed the capacity of the motorcycle's electrical system, an electric failure could result, which could cause a dangerous loss of lights or engine power.

### Aftermarket Tires and Rims

The tires and rims that came with your motorcycle were designed to match the performance capabilities and to provide the best combination of handling, braking, and comfort. Other tires, rims, sizes, and combinations may not be appropriate. See page 7-17 for tire specifications and for information on servicing and replacing your tires.

### Transporting the Motorcycle

Be sure to observe following instructions before transporting the motorcycle in another vehicle.

- Remove all loose items from the motorcycle.
- Check that the fuel cock (if equipped) is in the off position and that there are no fuel leaks.
- Shift the transmission into gear (for models with a manual transmission).
- Secure the motorcycle with tie-downs or suitable straps that are attached to solid parts of the motorcycle, such as the frame or upper front fork triple clamp (and not, for example, to rubber-mounted handlebars or turn signals, or parts that could break). Choose the location for the straps carefully so the straps will not rub against painted surfaces during transport.
- The suspension should be compressed somewhat by the tie-downs, if possible, so that the motorcycle will not bounce excessively during transport.

EAUJ0033

### Helmets

Operating this vehicle without an approved motorcycle helmet increases your chances of a severe head injury or death in the event of an accident. The majority of fatalities from motorcycle or scooter accidents are the result of head injuries. The use of a safety helmet is the single most critical factor in the prevention or reduction of head injuries.

### Always select an approved motorcycle helmet

Pay attention to the following when choosing a motorcycle helmet.

- The helmet must meet the safety standard "TIS".
- The helmet size must match the size of the rider's head.
- Never subject a helmet to heavy shocks.

### Wearing the helmet correctly

Always connect the chin strap. In the case of an accident, the helmet has a much less chance of coming off if the chin strap is connected.

**Correct usage**



ZAUU0003

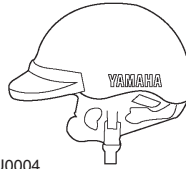

ZAUU0004



ZAUU0006

**Wrong usage**



ZAUU0007

- Full-type: use only for riding at low to mid-range speeds



ZAUU0005

**Types of helmets and their usage**

- Half-type: use only for riding at low speeds
- Full-face-type: use for riding at mid-range to high speeds

# Description

EAU10411

## Left view

3

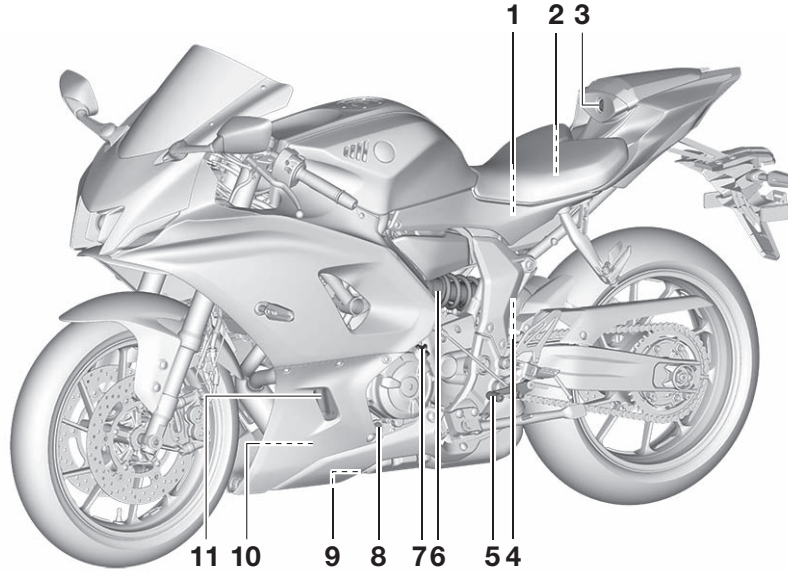

1. Battery (page 7-31)
2. Fuses (page 7-32)
3. Seat lock (page 4-18)
4. Rebound damping force adjuster (page 4-23)
5. Shift pedal (page 4-13)
6. Spring preload adjuster (page 4-23)
7. Engine oil filler cap (page 7-11)
8. Engine oil level check window (page 7-11)

9. Engine oil drain bolt (page 7-11)
10. Engine oil filter cartridge (page 7-11)
11. Coolant reservoir (page 7-14)



## Right view

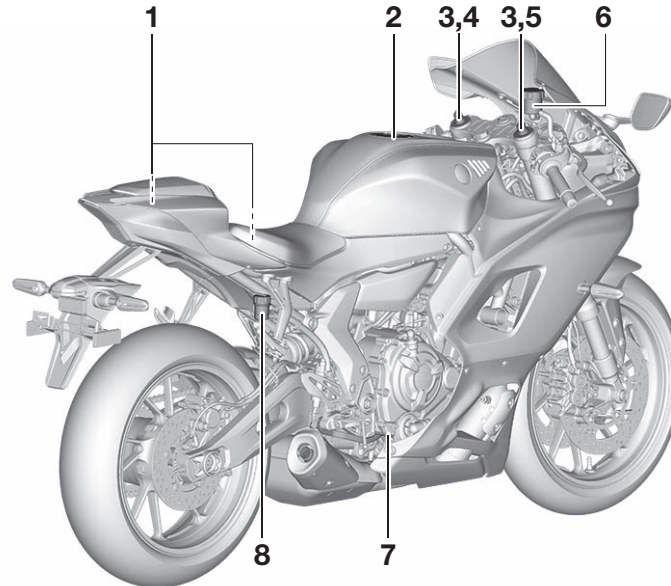

1. Tool kit (page 7-2)
2. Fuel tank cap (page 4-15)
3. Spring preload adjuster (page 4-21)
4. Compression damping force adjuster (page 4-21)
5. Rebound damping force adjuster (page 4-21)
6. Front brake fluid reservoir (page 7-22)
7. Brake pedal (page 4-14)
8. Rear brake fluid reservoir (page 7-22)

## Controls and instruments

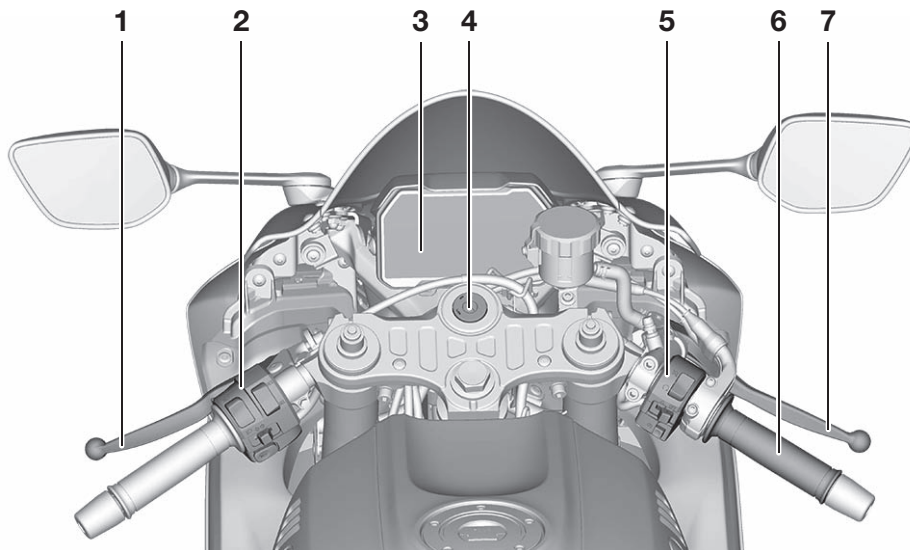

1. Clutch lever (page 4-13)
2. Left handlebar switches (page 4-11)
3. Multi-function meter unit (page 4-5)
4. Main switch/steering lock (page 4-2)
5. Right handlebar switches (page 4-11)
6. Throttle grip (page 7-17)
7. Brake lever (page 4-14)

## Immobilizer system

EAU1097B

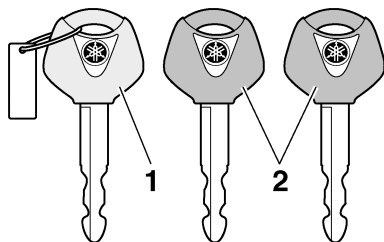

1. Code re-registering key (red bow)
2. Standard keys (black bow)

This vehicle is equipped with an immobilizer system to help prevent theft by re-registering codes in the standard keys. This system consists of the following:

- a code re-registering key
- two standard keys
- a transponder (in each key)
- an immobilizer unit (on the vehicle)
- an ECU (on the vehicle)
- a system indicator light (page 4-4)

### About the keys

The code re-registering key is used to register codes in each standard key. Store the code re-registering key in a safe place. Use a standard key for daily operation.

When key replacement or re-registering is necessary, bring the vehicle and the code re-registering key along with any remaining standard keys to a Yamaha dealer to have them re-registered.

### TIP

- Keep the standard keys as well as keys of other immobilizer systems away from the code re-registering key.
- Keep other immobilizer system keys away from the main switch as they may cause signal interference.

can still be used to start the vehicle. However, registering a new standard key is impossible. If all keys have been lost or damaged, the entire immobilizer system must be replaced. Therefore, handle the keys carefully.

- Do not submerge in water.
- Do not expose to high temperatures.
- Do not place near magnets.
- Do not place near items that transmit electrical signals.
- Do not handle roughly.
- Do not grind or alter.
- Do not disassemble.
- Do not put two keys of any immobilizer system on the same key ring.

ECA11823

### NOTICE

**DO NOT LOSE THE CODE RE-REGISTERING KEY! CONTACT YOUR DEALER IMMEDIATELY IF IT IS LOST! If the code re-registering key is lost, the existing standard keys**

# Instrument and control functions

## Main switch/steering lock

EAU10474

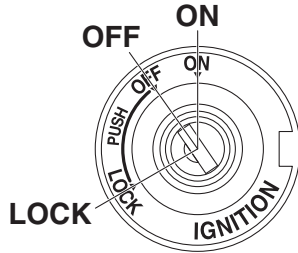

4

The main switch/steering lock controls the ignition and lighting systems, and is used to lock the steering. The various positions are described below.

### TIP

Be sure to use the standard key (black bow) for regular use of the vehicle. To minimize the risk of losing the code re-registering key (red bow), keep it in a safe place and only use it for code re-registering.

### ON

All electrical circuits are supplied with power and the vehicle lights are turned on. The engine can be started. The key cannot be removed.

EAU84035

### TIP

- The headlight(s) will turn on when the engine is started.
- To prevent battery drain, do not leave the key in the “ON” position without the engine running.

### OFF

All electrical systems are off. The key can be removed.

EAU10664

### **⚠ WARNING**

**Never turn the key to “OFF” or “LOCK” while the vehicle is moving. Otherwise the electrical systems will be switched off, which may result in loss of control or an accident.**

EWA10062

### LOCK

The steering is locked and all electrical systems are off. The key can be removed.

EAU73803

### To lock the steering

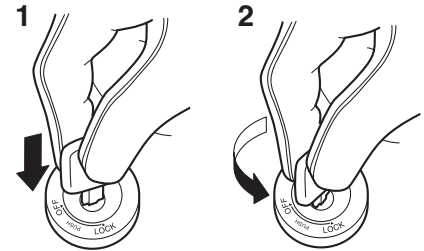

1. Push.
2. Turn.

1. Turn the handlebars all the way to the left.
2. With the key in the “OFF” position, push the key in and turn it to “LOCK”.
3. Remove the key.

## TIP \_\_\_\_\_

If the steering will not lock, try turning the handlebars back to the right slightly.

## To unlock the steering

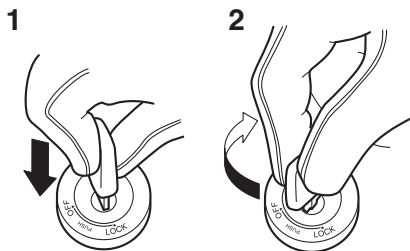

1. Push.
2. Turn.

Push the key in and turn it to “OFF”.

## Indicator lights and warning lights

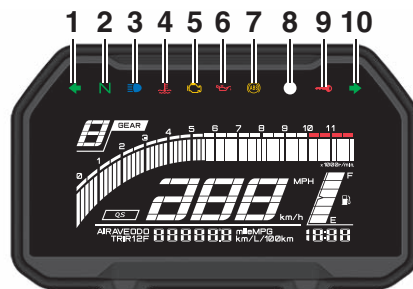

1. Left turn signal indicator light “←”
2. Neutral indicator light “N”
3. High beam indicator light “☰”
4. Coolant temperature warning light “🌡️”
5. Engine trouble warning light “🔧”
6. Oil pressure warning light “🛢️”
7. ABS warning light “(ABS)”
8. Shift timing indicator light
9. Immobilizer system indicator light “🔑”
10. Right turn signal indicator light “→”

## Turn signal indicator lights “←” and “→”

Each indicator light will flash when its corresponding turn signal lights are flashing.

## Neutral indicator light “N”

This indicator light comes on when the transmission is in the neutral position.

## High beam indicator light “☰”

This indicator light comes on when the high beam of the headlight is switched on.

## Oil pressure warning light “🛢️”

This warning light comes on if the engine oil pressure is low.

## TIP \_\_\_\_\_

When the vehicle is turned on, the light should come on, go off briefly, and then remain on until the engine is started. Otherwise, have a Yamaha dealer check the vehicle.

## NOTICE \_\_\_\_\_

If the warning light comes on when the engine is running, stop the engine and check the oil level. If the oil level is low, add sufficient oil of the recommended type. If the warning

# Instrument and control functions

light remains on after adding oil, stop the engine and have a Yamaha dealer check the vehicle.

## Coolant temperature warning light “”

EAU88880

This warning light comes on when the engine is overheating. If this occurs, stop the engine immediately and allow the engine to cool. (See page 7-37.) For vehicles with a radiator fan, the radiator fan(s) automatically switch on or off according to the coolant temperature.

### TIP

When the vehicle is turned on, the light will come on for a few seconds, and then go off. If the light does not come on, or if the light remains on, have a Yamaha dealer check the vehicle.

ECA10022

### NOTICE

Do not continue to operate the engine if it is overheating.

## Engine trouble warning light “”

EAU88920

This warning light comes on if a problem is detected in the engine or other vehicle control system. If this occurs, have a Yamaha dealer check the on-board diagnostic system.

### TIP

When the vehicle is turned on, this light should come on for a few seconds and then go off. Otherwise, have a Yamaha dealer check vehicle.

## ABS warning light “”

EAU93230

This warning light comes on when the vehicle is first turned on, and goes off after starting riding. If the warning light comes on while riding, the anti-lock brake system may not work correctly.

EWA21120

### WARNING

If the ABS warning light does not turn off after reaching 5 km/h (3 mi/h), or if the warning light comes on while riding:

- Use extra caution to avoid possible wheel lock during emergency braking.

- Have a Yamaha dealer check the vehicle as soon as possible.

## Shift timing indicator light

EAU92970

This indicator light can be set to come on and go off at select engine speeds. (See page 4-10.)

### TIP

When the vehicle is turned on, the light should flash and then go off. If the light does not flash, or if the light remains on, have a Yamaha dealer check the vehicle.

## Immobilizer system indicator light “”

EAU92710

When the main switch is turned off and 30 seconds have passed, the indicator light will flash steadily to indicate the immobilizer system is enabled. After 24 hours have passed, the indicator light will stop flashing, however the immobilizer system is still enabled.

## TIP

When the vehicle is turned on, this light should come on for a few seconds and then go off. If the light does not come on, or if the light remains on, have a Yamaha dealer check the vehicle.

## Transponder interference

If the immobilizer system indicator light flashes in the pattern, slowly 5 times then quickly 2 times, this could be caused by transponder interference. If this occurs, try the following.

1. Make sure there are no other immobilizer keys close to the main switch.
2. Use the code re-registering key to start the engine.
3. If the engine starts, turn it off, and try starting the engine with the standard keys.
4. If one or both of the standard keys do not start the engine, take the vehicle and all 3 keys to a Yamaha dealer to have the standard keys re-registered.

## Multi-function meter unit

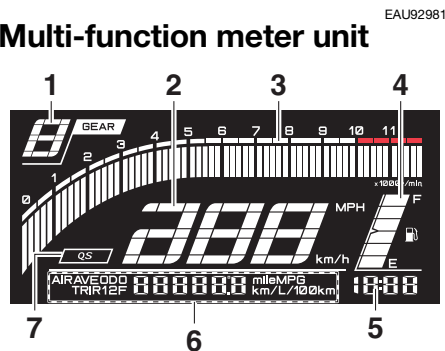

1. Transmission gear display
2. Speedometer
3. Tachometer
4. Fuel meter
5. Clock
6. Multi-function display
7. Quick shifter indicator “QS” (if equipped)

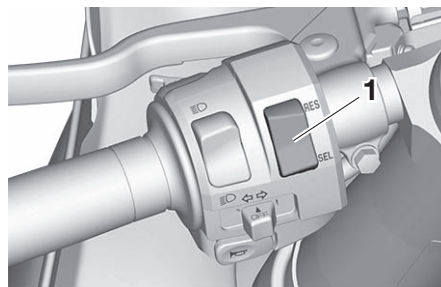

1. “SEL/RES” switch

The multi-function meter unit is also equipped with a display brightness and shift timing indicator light settings mode.

## WARNING

Be sure to stop the vehicle before making any setting changes to the multi-function meter unit. Changing settings while riding can distract the operator and increase the risk of an accident.

## TIP

The multi-function meter is controlled using the “SEL/RES” switch. See page 4-13 for more information.

## Switching the display units

The display units can be switched between kilometers and miles. To switch the display units, set the multi-function display to the odometer or a tripmeter, and then hold the “SEL” switch until the display units change.

# Instrument and control functions

## Speedometer

The speedometer shows the vehicle's traveling speed.

EAU86831

## Tachometer

EAU87170

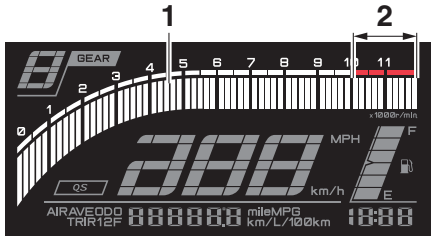

1. Tachometer
2. Tachometer red zone

The tachometer allows the rider to monitor the engine speed and keep it within the ideal power range.

ECA10032

## NOTICE

**Do not operate the engine in the tachometer red zone.**

**Red zone: 10000 r/min and above**

## Fuel meter

EAU86842

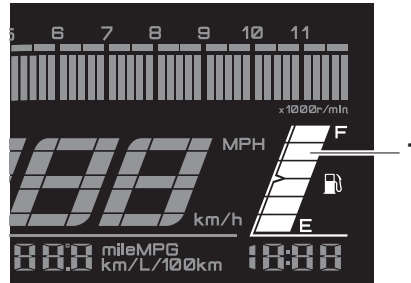

1. Fuel meter

The fuel meter indicates the amount of fuel in the fuel tank. The display segments of the fuel meter disappear from “F” (full) towards “E” (empty) as the fuel level decreases. When approximately 2.5 L (0.66 US gal, 0.55 Imp.gal) of fuel remains, the last segment starts flashing. Refuel as soon as possible.

## TIP

If a problem is detected in the electrical circuit, the fuel level segments will flash repeatedly. If this occurs, have a Yamaha dealer check the vehicle.

## NOTICE

**Do not let the vehicle run completely out of fuel. This may cause damage to the catalytic converter.**

ECA90121

## Clock

EAU93011

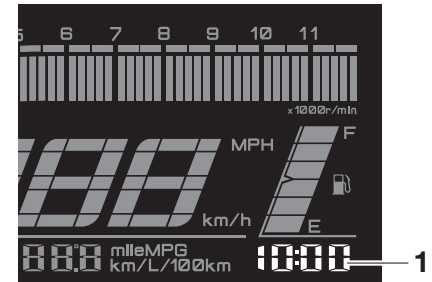

1. Clock

The clock uses a 12-hour time system.

## To set the clock

1. Turn the vehicle off.
2. While holding the “RES” switch, turn the vehicle on. Continue holding the “RES” switch until the hour digits start flashing.
3. Use the “SEL” switch to set the hours.



# Instrument and control functions

4. Push the “RES” switch and the minute digits will start flashing.
5. Use the “SEL” switch to set the minutes.
6. Push the “RES” switch to confirm the setting.

## Transmission gear display

EAU87391

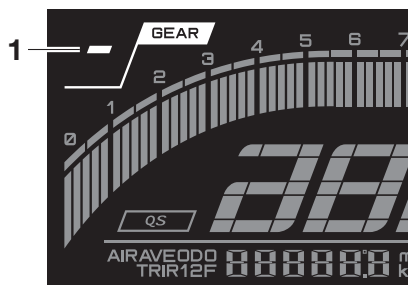

1. Transmission gear display

This display shows the selected gear. The neutral position is indicated by “-” and by the neutral indicator light.

## Quick shifter indicator “QS” (if equipped)

EAU93021

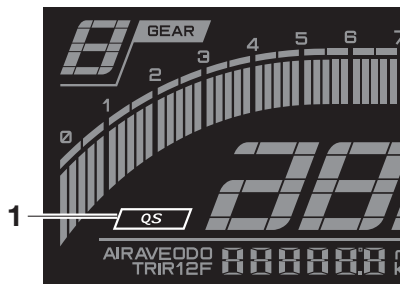

1. Quick shifter indicator “QS” (if equipped)

This indicator comes on when the quick shifter is turned on.

## Multi-function display

EAU93730

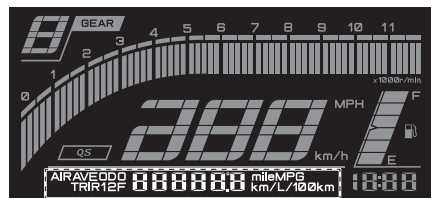

1

1. Multi-function display

The multi-function display is equipped with the following:

- an odometer (ODO)
- two tripmeters (TRIP 1 and TRIP 2)
- a fuel reserve tripmeter (TRIP F)
- an instantaneous fuel consumption display (km/L, L/100 km, or MPG)
- an average fuel consumption display (AVE\_ \_ km/L, AVE\_ \_ L/100 km, or AVE\_ \_ MPG)
- a coolant temperature display ( \_ °C)
- an air temperature display (Air\_ \_ °C)

Use the “SEL” switch to change the display in the following order:

ODO → TRIP 1 → TRIP 2 → TRIP F → km/L or L/100 km or MPG → AVE\_ \_ km/L or AVE\_ \_ L/100 km or AVE\_ \_ MPG → \_ °C → Air\_ \_ °C → ODO

## TIP

- The fuel reserve tripmeter appears only when you are low on fuel.
- Use the “RES” switch to change the display in the reverse order.

# Instrument and control functions

## Odometer

EAU86891

The odometer shows the total distance traveled by the vehicle.

### TIP

The odometer will lock at “999999” and cannot be reset.

4

## Tripmeters

EAU89142

The tripmeters show the distance traveled since they were last reset.

To reset a tripmeter, change the display to the tripmeter you want to reset, and then hold the “RES” switch until it is reset.

### TIP

The tripmeters will reset and continue counting after 9999.9 is reached.

## Fuel reserve tripmeter

EAU89152

If the last segment of the fuel meter starts flashing, the display automatically changes to the fuel reserve tripmeter “TRIP F” and starts counting the distance traveled from that point.

To reset the fuel reserve tripmeter, change the display to the fuel reserve tripmeter, and then hold the “RES” switch until it is reset.

### TIP

If you do not reset the fuel reserve tripmeter manually, it will reset automatically and disappear from the display after refueling and traveling 5 km (3 mi).

## Instantaneous fuel consumption display

EAU89181

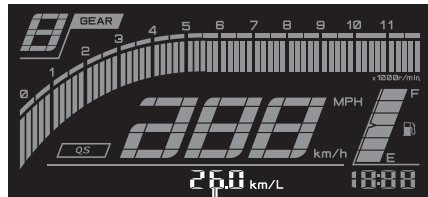

1. Instantaneous fuel consumption display

This display shows the fuel consumption under the current riding conditions. It can be set to either “km/L” or “L/100 km”, or “MPG” when using miles. To switch the fuel consumption

measurement units, hold the “SEL” switch until the measurement units change.

- “km/L”: the distance that can be traveled on 1.0 L of fuel.
- “L/100 km”: the amount of fuel necessary to travel 100 km.
- “MPG”: the distance that can be traveled on 1.0 Imp.gal of fuel.

### TIP

When traveling under 10 km/h (6 mi/h), “-.-” is displayed.

EAU87790

### TIP

The instantaneous fuel consumption function should be used for general reference only. Do not use this figure to estimate the distance that can be traveled on the current tank of fuel.

## Average fuel consumption display

EAU89194

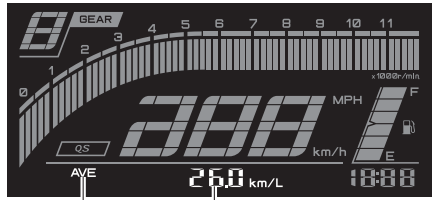

1

1. Average fuel consumption display

This display shows the average fuel consumption since it was last reset. The average fuel consumption display can be set to either “AVE\_ \_ \_ km/L” or “AVE\_ \_ \_ L/100 km”, or “AVE\_ \_ \_ MPG” when using miles. To switch the fuel consumption measurement units, hold the “SEL” switch until the measurement units change.

- “AVE\_ \_ \_ km/L”: the average distance that can be traveled on 1.0 L of fuel.
- “AVE\_ \_ \_ L/100 km”: the average amount of fuel necessary to travel 100 km.

- “AVE\_ \_ \_ MPG”: the average distance that can be traveled on 1.0 Imp.gal of fuel.

### TIP

- To reset the display, change the display to the average fuel consumption display, and hold the “RES” switch until it resets.
- After resetting, “-.-” is shown until the vehicle has traveled some distance.

## Coolant temperature display

EAU93210

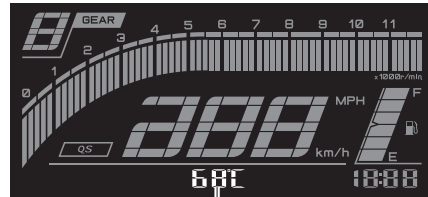

1

1. Coolant temperature display

This display shows the coolant temperature from 40 °C to 116 °C in 1 °C increments.

If the message “HI” flashes, stop the vehicle, then stop the engine, and let it cool. (See page 7-37.)

### TIP

- When the coolant temperature is below 40 °C, “Lo” will be displayed.
- The coolant temperature varies with changes in the weather and engine load.

## Air temperature display

EAU93223

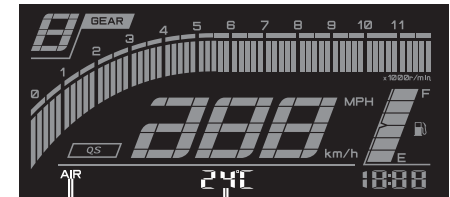

1

1. Air temperature display

This display shows the air temperature from –9 °C to 50 °C in 1 °C increments. The temperature displayed may vary from the actual ambient temperature.

# Instrument and control functions

## TIP

When the temperature is over 51°C or below -9 °C, “\_ \_” will be displayed.

EAU93241

## Display brightness and shift timing indicator light settings mode

The following settings can be adjusted in order:

- Display brightness
- Shift timing indicator light ON / FLASH / OFF
- Shift timing indicator light ON r/min
- Shift timing indicator light OFF r/min
- Shift timing indicator light brightness

### To access the settings mode

1. Turn the vehicle off.
2. Hold the “SEL” switch, turn the vehicle on and continue holding the “SEL” switch until the display changes to the display brightness control mode.
3. Use the “RES” switch to change the setting values.

4. Push the “SEL” switch to confirm the selected setting value and cycle to the next setting in the order listed above.

## TIP

The settings mode will exit after all settings are confirmed.

## Display brightness



1

1. Display brightness

An brightness level indicator bar will appear at the bottom of the display. Use the “RES” switch to select the desired brightness level and push the “SEL” to confirm it.

## Shift timing indicator light

The shift timing indicator light has 3 settings:

- ON setting: the shift timing indicator light will come on when the set engine speed is reached. When this setting is selected, the indicator light will come on and stay on until the next setting is selected using the “RES” switch or confirmed with the “SEL” switch.
- FLASH setting: the shift timing indicator light will flash when the set engine speed is reached. When this setting is selected, the shift timing indicator light will flash 4 times per second until the next setting is selected using the “RES” switch or confirmed with the “SEL” switch.
- OFF setting: the shift timing indicator light is deactivated. When this setting is selected, the shift timing indicator light will flash once every 2 seconds until the next setting is selected using the “RES” switch or confirmed with the “SEL” switch.

## Shift timing indicator light ON r/min

The shift timing indicator light can be set between 6000 r/min and 12000 r/min in increments of 200 r/min. While changing this setting, the shift timing indicator light will come on and stay on and the selected increment will be displayed on the tachometer.

Use the “RES” switch to select the desired engine speed for activating the shift timing indicator light.

## Shift timing indicator light OFF r/min

The shift timing indicator light can be set between 6000 r/min and 12000 r/min in increments of 200 r/min. While changing this setting, the shift timing indicator light will flash and the selected increment will be displayed on the tachometer.

Use the “RES” switch to select the desired engine speed for deactivating the shift timing indicator light.

## TIP \_\_\_\_\_

Be sure to set the OFF r/min to a higher engine speed than the ON r/min setting otherwise the shift timing indicator light will not come on while riding.

## Shift timing indicator light brightness





The shift timing indicator light will come on and stay on until the setting is confirmed. The brightness level of the light will change as the level is adjusted.

Use the “RES” switch to select the desired brightness level and push the “SEL” to confirm it.

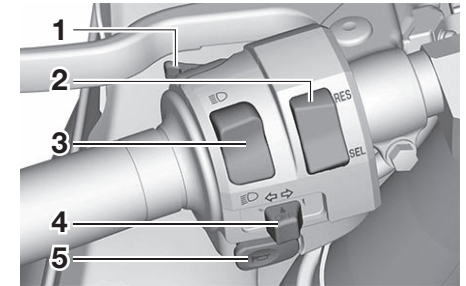
## Handlebar switches

### Left



1. Pass switch “”
2. “SEL/RES” switch
3. Dimmer switch “/”
4. Turn signal switch “/”
5. Horn switch “”

# Instrument and control functions

## Right

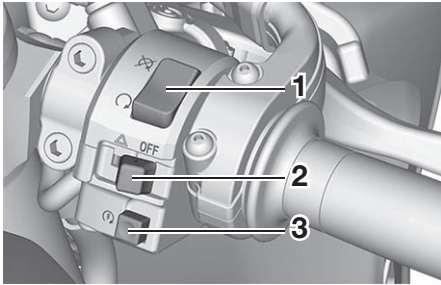

1. Engine stop switch “/”
2. Hazard switch “OFF/”
3. Start switch “”

### Pass switch “/”

EAU12352

Press this switch to flash the headlight.

### TIP

When the dimmer switch is set to “”, the passing switch has no effect.

### Dimmer switch “/”

EAU12402

Set this switch to “” for the high beam and to “” for the low beam.

### Turn signal switch “/”

EAU12461

To signal a right-hand turn, push this switch to “”. To signal a left-hand turn, push this switch to “”. When released, the switch returns to the center position. To cancel the turn signal lights, push the switch in after it has returned to the center position.

### Horn switch “”

EAU12650

Press this switch to sound the horn.

### Engine stop switch “/”

EAU12664

Set this switch to “” (run) before starting the engine. Set this switch to “” (stop) to stop the engine in case of an emergency, such as in the event of an overturn or if the throttle is stuck.

### Start switch “”

EAU12713

Push this switch to crank the engine with the starter. See page 6-2 for starting instructions prior to starting the engine.

### Hazard switch “OFF/”

EAU88273

Use this switch to turn on the hazard lights (simultaneous flashing of all turn signal lights). The hazard lights are used in case of an emergency or to warn other drivers when your vehicle is stopped where it might be a traffic hazard.

The hazard lights can be turned on or off only when the main switch is in the “ON” position. You can turn the main switch to the “OFF” or “LOCK” position, and the hazard lights will continue to flash. To turn off the hazard lights, turn the main switch to the “ON” position and operate the hazard switch again.

ECA10062

### NOTICE

**Do not use the hazard lights for an extended length of time with the engine not running, otherwise the battery may discharge.**

## “SEL/RES” switch

EAU88941

This switch is used to make setting and display changes in the multi-function meter unit. See page 4-5 for more information.

To use the “SEL” switch, move the “SEL/RES” switch in direction (a). To use the “RES” switch, move the “SEL/RES” switch in direction (b).

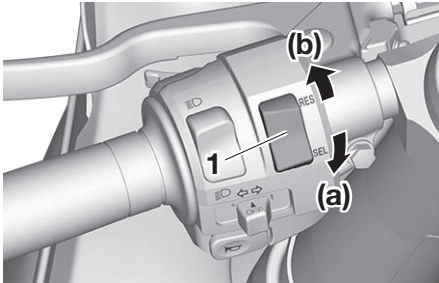

1. “SEL/RES” switch

## Clutch lever

EAU12823

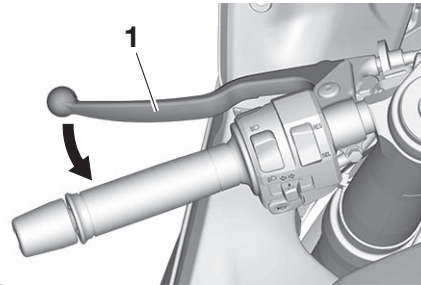

1. Clutch lever

To disengage the drivetrain from the engine, such as when shifting gears, pull the clutch lever toward to the handlebar. Release the lever to engage the clutch and transmit power to the rear wheel.

### TIP

The lever should be pulled rapidly and released slowly for smooth shifting. (See page 6-3.)

## Shift pedal

EAU12876

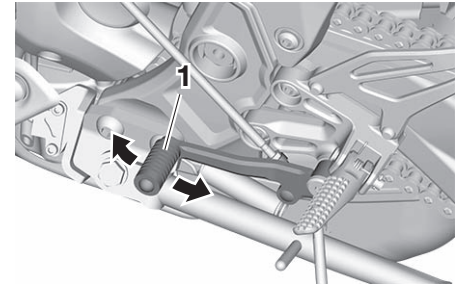

1. Shift pedal

The shift pedal is located on the left side of the motorcycle. To shift the transmission to a higher gear, move the shift pedal up. To shift the transmission to a lower gear, move the shift pedal down. (See page 6-3.)

# Instrument and control functions

## Brake lever

EAU93080

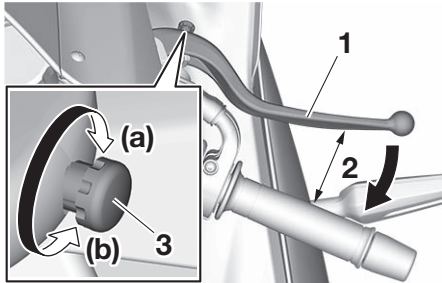

1. Brake lever
2. Distance
3. Brake lever position adjusting knob

The brake lever is located on the right side of the handlebar. To apply the front brake, pull the lever toward the throttle grip.

The brake lever is equipped with a brake lever position adjusting knob. To adjust the distance between the brake lever and the throttle grip, turn the adjusting knob while holding the lever pushed away from the throttle grip.

Turn the adjusting knob in direction (a) to increase the distance. Turn the adjusting knob in direction (b) to decrease the distance.

## Brake pedal

EAU12944



1. Brake pedal

The brake pedal is located on the right side of the motorcycle. To apply the rear brake, press down on the brake pedal.

## ABS

EAU93090

The Yamaha ABS (Anti-lock Brake System) features a dual electronic control system, which acts on the front and rear brakes independently.

Operate the brakes with ABS as you would conventional brakes. If the ABS is activated, a pulsating sensation may be felt at the brake lever or brake pedal. In this situation, continue to apply the brakes and let the ABS work; do not “pump” the brakes as this will reduce braking effectiveness.

EWA16051

### **WARNING**

**Always keep a sufficient distance from the vehicle ahead to match the riding speed even with ABS.**

- **The ABS performs best with long braking distances.**
- **On certain surfaces, such as rough or gravel roads, the braking distance may be longer with the ABS than without.**

The ABS is monitored by an ECU, which will revert the system to conventional braking if a malfunction occurs.



## TIP

- The ABS performs a self-diagnostic test each time the vehicle first starts off after the key is turned to “ON” and the vehicle has traveled at a speed of 5 km/h (3 mi/h) or higher. During this test, a “clicking” noise can be heard from the hydraulic control unit, and if the brake lever or brake pedal is even slightly applied, a vibration can be felt at the lever and pedal, but these do not indicate a malfunction.
- This ABS has a test mode which allows the owner to experience the pulsation at the brake lever or brake pedal when the ABS is operating. However, special tools are required, so please consult your Yamaha dealer.

ECA20100

## NOTICE

**Be careful not to damage the wheel sensor or wheel sensor rotor; otherwise, improper performance of the ABS will result.**

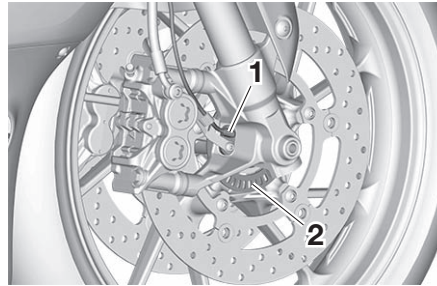

1. Front wheel sensor
2. Front wheel sensor rotor

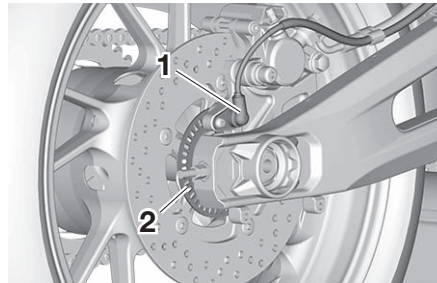

1. Rear wheel sensor
2. Rear wheel sensor rotor

## Fuel tank cap

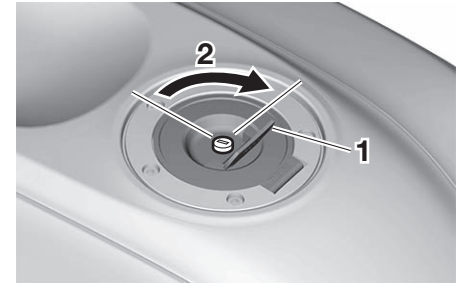

1. Fuel tank cap lock cover
2. Unlock.

### To open the fuel tank cap

Open the fuel tank cap lock cover, insert the key, and then turn it 1/4 turn clockwise. The lock will be released and the fuel tank cap can be opened.

### To close the fuel tank cap

With the key still inserted, push down the fuel tank cap. Turn the key 1/4 turn counterclockwise, remove it, and then close the lock cover.

# Instrument and control functions

## TIP

The fuel tank cap cannot be closed unless the key is in the lock. In addition, the key cannot be removed if the cap is not properly closed and locked.

EWA11092

## WARNING

Make sure that the fuel tank cap is properly closed after filling fuel. Leaking fuel is a fire hazard.

## Fuel

Make sure there is sufficient gasoline in the tank.

EAU13222

EWA10882

## WARNING

Gasoline and gasoline vapors are extremely flammable. To avoid fires and explosions and to reduce the risk of injury when refueling, follow these instructions.

1. Before refueling, turn off the engine and be sure that no one is sitting on the vehicle. Never refuel while smoking, or while in the vicinity of sparks, open flames, or other sources of ignition such as the pilot lights of water heaters and clothes dryers.
2. Do not overfill the fuel tank. When refueling, be sure to insert the pump nozzle into the fuel tank filler hole. Stop filling when the fuel reaches the bottom of the filler tube. Because fuel expands when it heats up, heat from the engine or the sun can cause fuel to spill out of the fuel tank.

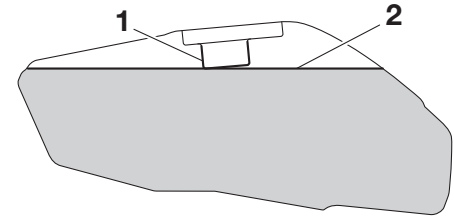

1. Fuel tank filler tube
2. Maximum fuel level

3. Wipe up any spilled fuel immediately. **NOTICE: Immediately wipe off spilled fuel with a clean, dry, soft cloth, since fuel may deteriorate painted surfaces or plastic parts.** [ECA10072]
4. Be sure to securely close the fuel tank cap.

EWA15152

## WARNING

Gasoline is poisonous and can cause injury or death. Handle gasoline with care. Never siphon gasoline by mouth. If you should swallow some gasoline or inhale a lot of gasoline vapor, or get some gasoline in your eyes, see your doctor immedi-

**ately. If gasoline spills on your skin, wash with soap and water. If gasoline spills on your clothing, change your clothes.**

EAU86081

Your Yamaha engine was designed to use unleaded gasoline with a research octane number of 90 or higher. If engine knocking or pinging occurs, use a gasoline of a different brand or higher octane rating.

**Recommended fuel:**

Unleaded gasoline (E10 acceptable)

**Octane number (RON):**

90

**Fuel tank capacity:**

13 L (3.4 US gal, 2.9 Imp.gal)

**Fuel tank reserve:**

2.5 L (0.66 US gal, 0.55 Imp.gal)

**Gasohol**

There are two types of gasohol: gasohol containing ethanol and that containing methanol. Gasohol containing ethanol can be used if the ethanol content does not exceed 10% (E10). Gasohol containing methanol is not

recommended by Yamaha because it can cause damage to the fuel system or vehicle performance problems.

ECA11401

**NOTICE**

**Use only unleaded gasoline. The use of leaded gasoline will cause severe damage to internal engine parts, such as the valves and piston rings, as well as to the exhaust system.**

## Fuel tank overflow hose

EAU86160

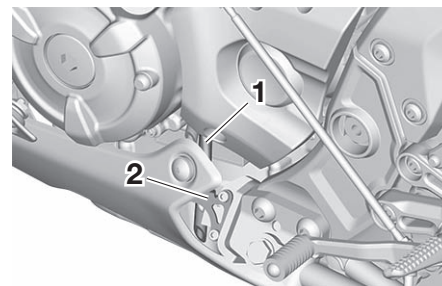

1. Fuel tank overflow hose
2. Clamp

The overflow hose drains excess gasoline and directs it safely away from the vehicle.

Before operating the vehicle:

- Check the fuel tank overflow hose connection.
- Check the fuel tank overflow hose for cracks or damage, and replace it if necessary.
- Make sure that the fuel tank overflow hose is not blocked, and clean it if necessary.
- Make sure that the fuel tank overflow hose is positioned as shown.

# Instrument and control functions

**TIP** \_\_\_\_\_  
See page 7-11 for canister information.

## Catalytic converter

EAU13435

The exhaust system contains catalytic converter(s) to reduce harmful exhaust emissions.

EWA10863

### **⚠ WARNING** \_\_\_\_\_

**The exhaust system is hot after operation. To prevent a fire hazard or burns:**

- Do not park the vehicle near possible fire hazards such as grass or other materials that easily burn.
- Park the vehicle in a place where pedestrians or children are not likely to touch the hot exhaust system.
- Make sure that the exhaust system has cooled down before doing any maintenance work.
- Do not allow the engine to idle more than a few minutes. Long idling can cause a build-up of heat.

## Seats

EAU93101

### Passenger seat

To remove the passenger seat

1. Insert the key into the seat lock, and then turn it clockwise.

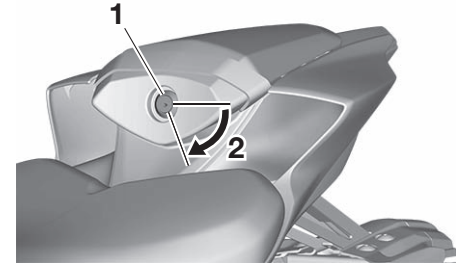

1. Seat lock
2. Unlock.

2. Lift the front of the passenger seat and pull it forward.

To install the passenger seat

1. Insert the projection on the rear of the passenger seat as shown.

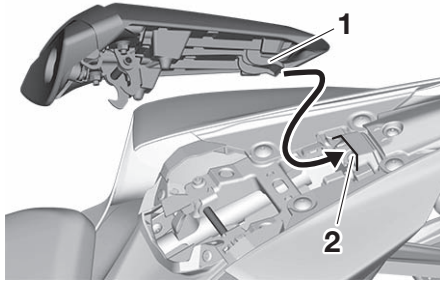

1. Projection
2. Seat holder

2. Insert the key into the seat lock, and then turn it clockwise. While holding the key turned in the clockwise position, push the front of the seat down to lock it in place.
3. Remove the key.

## Rider seat

### To remove the rider seat

1. Remove the passenger seat, and then remove the cover by removing the quick fasteners.

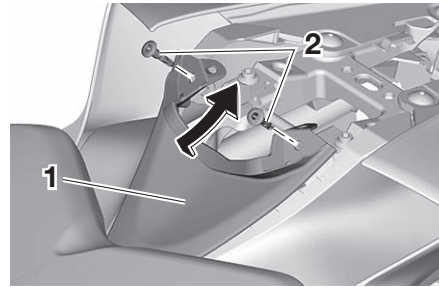

1. Cover
2. Quick fastener

2. Remove the hexagon wrench.

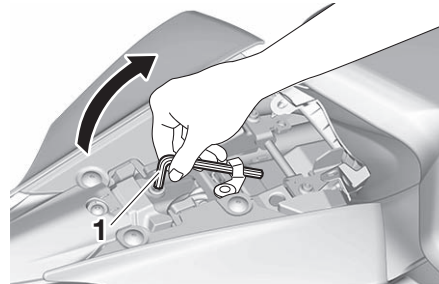

1. Hexagon wrench

3. Remove the bolts with the hexagon wrench.

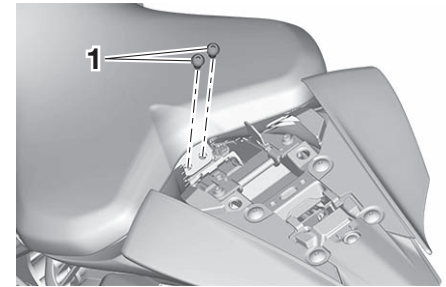

1. Bolt

4. Lift the seat rearward and up to remove it.

### To install the rider seat

1. Fit the slot in the seat onto the projection on the frame cross member as shown, and then place the seat in the original position.

# Instrument and control functions

4

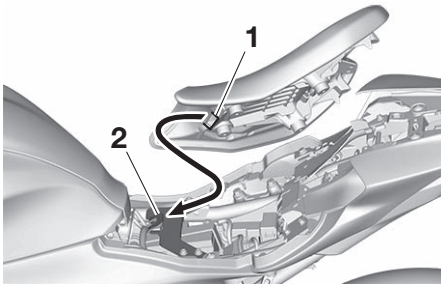

1. Slot
2. Projection

2. Install the bolts with the hexagon wrench.
3. Insert the hexagon wrench back into the original position.
4. Place the cover in the original position, and then install the quick fasteners.

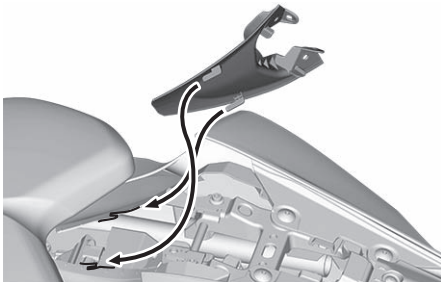

5. Install the passenger seat.

**TIP** \_\_\_\_\_  
Make sure that the seats are properly secured before riding.  
\_\_\_\_\_

## Rear view mirrors

EAU39672

The rear view mirrors of this vehicle can be folded forward or backward for parking in narrow spaces. Fold the mirrors back to their original position before riding.

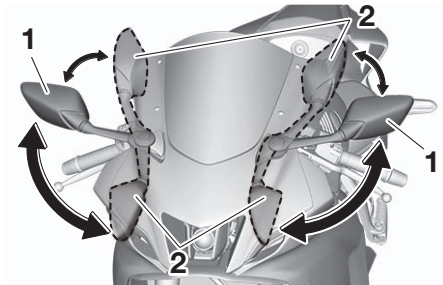

1. Riding position
2. Parking position

**⚠ WARNING** \_\_\_\_\_

EWA14372

**Be sure to fold the rear view mirrors back to their original position before riding.**  
\_\_\_\_\_

## Adjusting the front fork

EAU76345

EWA14671

### **WARNING**

Always adjust the spring preload on both fork legs equally, otherwise poor handling and loss of stability may result.

Each front fork leg is equipped with a spring preload adjusting bolt, the right front fork leg is equipped with a rebound damping force adjusting screw and the left front fork leg with a compression damping force adjusting screw.

ECA10102

### **NOTICE**

To avoid damaging the mechanism, do not attempt to turn beyond the maximum or minimum settings.

### Spring preload

Turn the adjusting bolt in direction (a) to increase the spring preload.

Turn the adjusting bolt in direction (b) to decrease the spring preload.

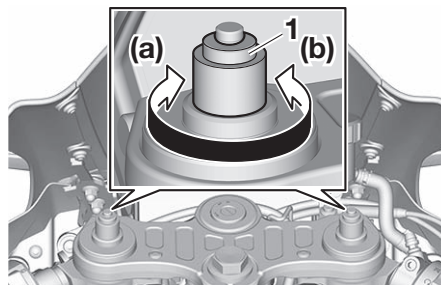

1. Spring preload adjusting bolt

The spring preload setting is determined by measuring distance A, shown in the illustration. The shorter distance A is, the higher the spring preload; the longer distance A is, the lower the spring preload.

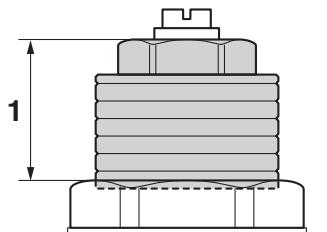

1. Distance A

### Spring preload setting:

Minimum (soft):

Distance A = 19.0 mm (0.75 in)

Standard:

Distance A = 14.0 mm (0.55 in)

Maximum (hard):

Distance A = 4.0 mm (0.16 in)

### Rebound damping force

The rebound damping force is adjusted on the right fork leg only.

Turn the adjusting screw in direction (a) to increase the rebound damping force.

Turn the adjusting screw in direction (b) to decrease the rebound damping force.

To set the rebound damping force, turn the adjuster in direction (a) until it stops, and then count the clicks in direction (b).

### TIP

Be sure to perform this adjustment on the right fork leg.

# Instrument and control functions

4

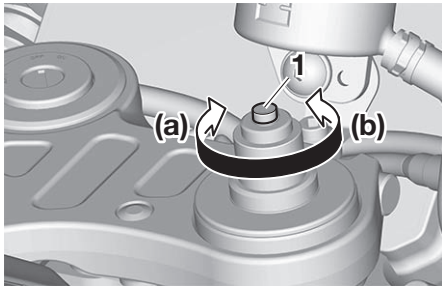

1. Rebound damping force adjusting screw

## Rebound damping setting:

Minimum (soft):

11 click(s) in direction (b)

Standard:

5 click(s) in direction (b)

Maximum (hard):

1 click(s) in direction (b)

## TIP

- When turning the damping force adjuster in direction (a), the 0 click position and the 1 click position may be the same.
- When turning the damping force adjuster in direction (b), it may click beyond the stated specifica-

tions, however such adjustments are ineffective and may damage the suspension.

## Compression damping force

The compression damping force is adjusted on the left fork leg only.

Turn the adjusting screw in direction (a) to increase the compression damping force.

Turn the adjusting screw in direction (b) to decrease the compression damping force.

To set the compression damping force, turn the adjuster in direction (a) until it stops, and then count the clicks in direction (b).

## TIP

Be sure to perform this adjustment on the left fork leg.

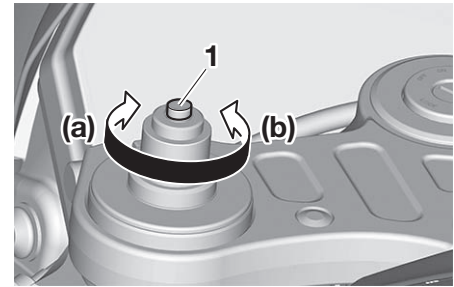

1. Compression damping force adjusting screw

## Compression damping setting:

Minimum (soft):

11 click(s) in direction (b)

Standard:

8 click(s) in direction (b)

Maximum (hard):

1 click(s) in direction (b)

## TIP

- When turning the damping force adjuster in direction (a), the 0 click position and the 1 click position may be the same.
- When turning the damping force adjuster in direction (b), it may click beyond the stated specifica-



tions, however such adjustments are ineffective and may damage the suspension.

## Adjusting the shock absorber assembly

EAU91870

This shock absorber assembly is equipped with a spring preload adjusting ring and a rebound damping force adjusting screw.

### NOTICE

**To avoid damaging the mechanism, do not attempt to turn beyond the maximum or minimum settings.**

ECA10102

### Spring preload

Turn the adjusting ring in direction (a) to increase the spring preload.

Turn the adjusting ring in direction (b) to decrease the spring preload.

Align the appropriate notch in the adjusting ring with the position indicator on the shock absorber.

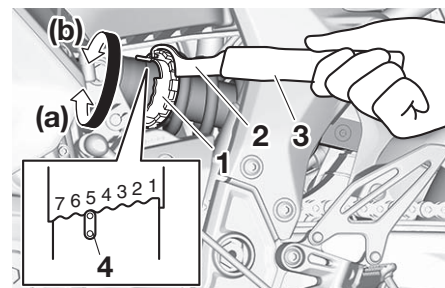

1. Spring preload adjusting ring
2. Special wrench
3. Extension bar
4. Position indicator

### TIP

Use the special wrench and extension bar in the additional tool kit to make this adjustment.

#### Spring preload setting:

Minimum (soft):

1

Standard:

5

Maximum (hard):

7

# Instrument and control functions

## Rebound damping force

Turn the adjusting screw in direction (a) to increase the rebound damping force.

Turn the adjusting screw in direction (b) to decrease the rebound damping force.

4

To set the rebound damping force, turn the adjuster in direction (a) until it stops, and then count the turns in direction (b).

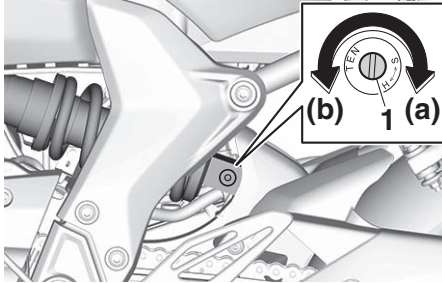

1. Rebound damping force adjusting screw

### Rebound damping setting:

Minimum (soft):

2+1/2 turn(s) in direction (b)

Standard:

1+1/2 turn(s) in direction (b)

Maximum (hard):

0 turn(s) in direction (b)

## TIP

When turning the damping force adjuster in direction (b), it may turn beyond the stated specifications, however such adjustments are ineffective and may damage the suspension.

EWA10222

## WARNING

This shock absorber assembly contains highly pressurized nitrogen gas. Read and understand the following information before handling the shock absorber assembly.

- Do not tamper with or attempt to open the cylinder assembly.
- Do not subject the shock absorber assembly to an open flame or other high heat source. This may cause the unit to explode due to excessive gas pressure.
- Do not deform or damage the cylinder in any way. Cylinder damage will result in poor damping performance.

- Do not dispose of a damaged or worn-out shock absorber assembly yourself. Take the shock absorber assembly to a Yamaha dealer for any service.

## DC connectors

EAU70642

This vehicle is equipped with additional wiring and DC connector(s) for the installation of optional electric accessories.

Consult a Yamaha dealer for more information regarding the location and capacity of the DC connector(s) and about what accessories are capable of being installed.

## Sidestand

EAU15306

The sidestand is located on the left side of the frame. Raise the sidestand or lower it with your foot while holding the vehicle upright.

### TIP

The built-in sidestand switch is part of the ignition circuit cut-off system, which cuts the ignition in certain situations. (See the following section for an explanation of the ignition circuit cut-off system.)

EWA10242

### WARNING

**The vehicle must not be ridden with the sidestand down, or if the sidestand cannot be properly moved up (or does not stay up), otherwise the sidestand could contact the ground and distract the operator, resulting in a possible loss of control. Yamaha's ignition circuit cut-off system has been designed to assist the operator in fulfilling the responsibility of raising the sidestand before starting off. Therefore, check**

**this system regularly and have a Yamaha dealer repair it if it does not function properly.**

# Instrument and control functions

---

EAU44895

## Ignition circuit cut-off system

This system prevents in-gear engine starts unless the clutch lever is pulled and the sidestand is up. Also, it will stop the running engine should the sidestand be lowered while the transmission is in gear.

Periodically check the system via the following procedure.

### TIP

- This check is most reliable if performed with a warmed-up engine.
- See pages 4-2 and 4-11 for switch operation information.

# Instrument and control functions

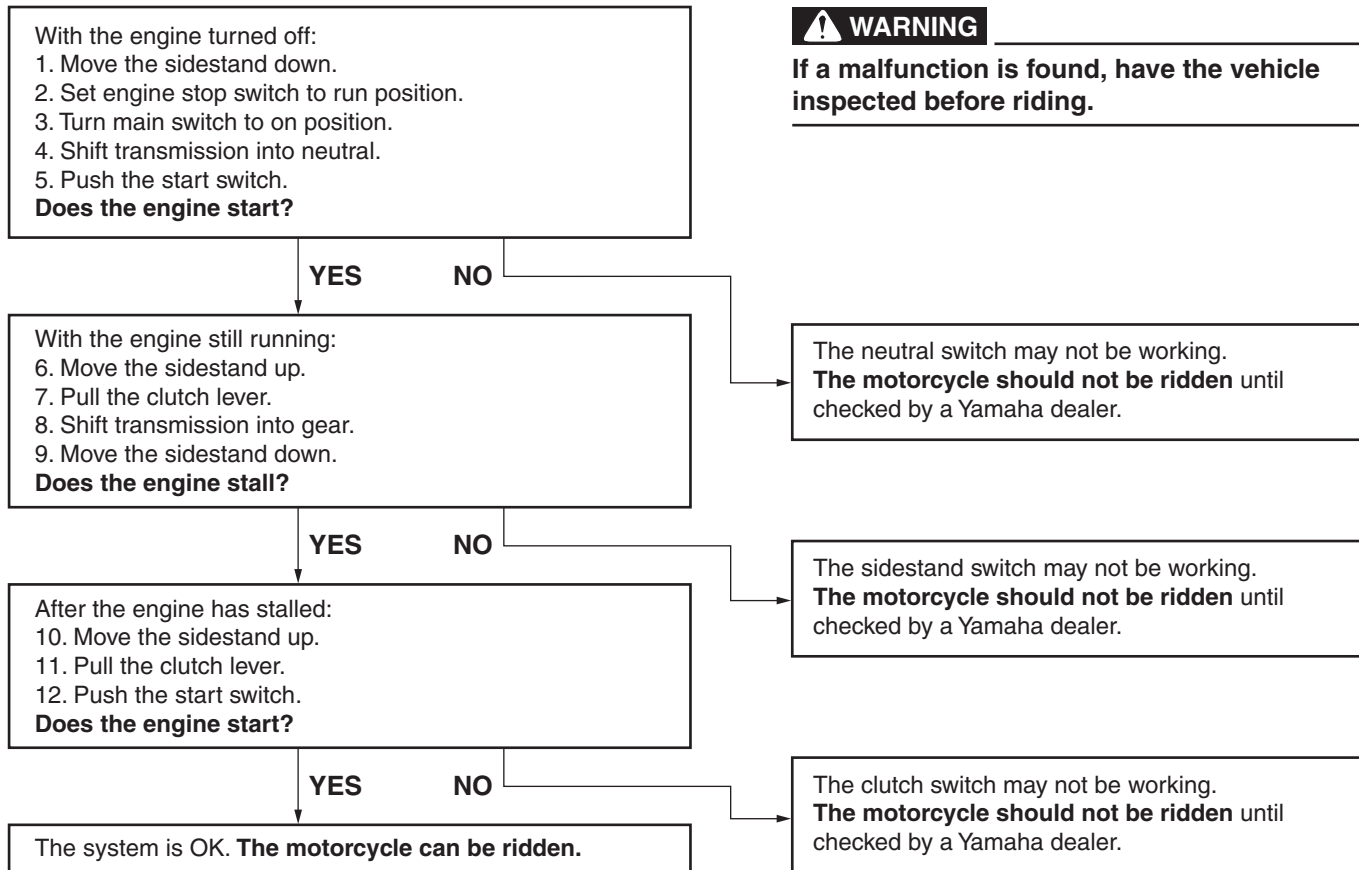

**WARNING**

If a malfunction is found, have the vehicle inspected before riding.

# For your safety – pre-operation checks

EAU1559B

Inspect your vehicle each time you use it to make sure the vehicle is in safe operating condition. Always follow the inspection and maintenance procedures and schedules described in the Owner's Manual.

EWA11152

## **WARNING**

**Failure to inspect or maintain the vehicle properly increases the possibility of an accident or equipment damage. Do not operate the vehicle if you find any problem. If a problem cannot be corrected by the procedures provided in this manual, have the vehicle inspected by a Yamaha dealer.**

5

Before using this vehicle, check the following points:

ITEM	CHECKS	PAGE
Fuel	<ul style="list-style-type: none"><li>• Check fuel level in fuel tank.</li><li>• Refuel if necessary.</li><li>• Check fuel line for leakage.</li><li>• Check fuel tank breather hose and overflow hose for obstructions, cracks or damage, and check hose connections.</li></ul>	4-16, 4-17
Engine oil	<ul style="list-style-type: none"><li>• Check oil level in engine.</li><li>• If necessary, add recommended oil to specified level.</li><li>• Check vehicle for oil leakage.</li></ul>	7-11
Coolant	<ul style="list-style-type: none"><li>• Check coolant level in reservoir.</li><li>• If necessary, add recommended coolant to specified level.</li><li>• Check cooling system for leakage.</li></ul>	7-14
Front brake	<ul style="list-style-type: none"><li>• Check operation.</li><li>• If soft or spongy, have Yamaha dealer bleed hydraulic system.</li><li>• Check brake pads for wear.</li><li>• Replace if necessary.</li><li>• Check fluid level in reservoir.</li><li>• If necessary, add specified brake fluid to specified level.</li><li>• Check hydraulic system for leakage.</li></ul>	7-22, 7-22

# For your safety – pre-operation checks

ITEM	CHECKS	PAGE
<b>Rear brake</b>	<ul style="list-style-type: none"> <li>• Check operation.</li> <li>• If soft or spongy, have Yamaha dealer bleed hydraulic system.</li> <li>• Check brake pads for wear.</li> <li>• Replace if necessary.</li> <li>• Check fluid level in reservoir.</li> <li>• If necessary, add specified brake fluid to specified level.</li> <li>• Check hydraulic system for leakage.</li> </ul>	7-22, 7-22
<b>Clutch</b>	<ul style="list-style-type: none"> <li>• Check operation.</li> <li>• Lubricate cable if necessary.</li> <li>• Check lever free play.</li> <li>• Adjust if necessary.</li> </ul>	7-20
<b>Throttle grip</b>	<ul style="list-style-type: none"> <li>• Make sure that operation is smooth.</li> <li>• Check throttle grip free play.</li> <li>• If necessary, have Yamaha dealer adjust throttle grip free play and lubricate cable and grip housing.</li> </ul>	7-17, 7-27
<b>Control cables</b>	<ul style="list-style-type: none"> <li>• Make sure that operation is smooth.</li> <li>• Lubricate if necessary.</li> </ul>	7-26
<b>Drive chain</b>	<ul style="list-style-type: none"> <li>• Check chain slack.</li> <li>• Adjust if necessary.</li> <li>• Check chain condition.</li> <li>• Lubricate if necessary.</li> </ul>	7-24, 7-26
<b>Wheels and tires</b>	<ul style="list-style-type: none"> <li>• Check for damage.</li> <li>• Check tire condition and tread depth.</li> <li>• Check air pressure.</li> <li>• Correct if necessary.</li> </ul>	7-17, 7-20
<b>Brake and shift pedals</b>	<ul style="list-style-type: none"> <li>• Make sure that operation is smooth.</li> <li>• Lubricate pedal pivoting points if necessary.</li> </ul>	7-27
<b>Brake and clutch levers</b>	<ul style="list-style-type: none"> <li>• Make sure that operation is smooth.</li> <li>• Lubricate lever pivoting points if necessary.</li> </ul>	7-28
<b>Sidestand</b>	<ul style="list-style-type: none"> <li>• Make sure that operation is smooth.</li> <li>• Lubricate pivot if necessary.</li> </ul>	7-28

## For your safety – pre-operation checks

ITEM	CHECKS	PAGE
<b>Chassis fasteners</b>	<ul style="list-style-type: none"><li>• Make sure that all nuts, bolts and screws are properly tightened.</li><li>• Tighten if necessary.</li></ul>	–
<b>Instruments, lights, signals and switches</b>	<ul style="list-style-type: none"><li>• Check operation.</li><li>• Correct if necessary.</li></ul>	–
<b>Sidestand switch</b>	<ul style="list-style-type: none"><li>• Check operation of ignition circuit cut-off system.</li><li>• If system is not working correctly, have Yamaha dealer check vehicle.</li></ul>	4-25



EAU15952

Read the Owner's Manual carefully to become familiar with all controls. If there is a control or function you do not understand, ask your Yamaha dealer.

EWA10272



**Failure to familiarize yourself with the controls can lead to loss of control, which could cause an accident or injury.**

EAU16842

## Engine break-in

There is never a more important period in the life of your engine than the period between 0 and 1600 km (1000 mi). For this reason, you should read the following material carefully.

Since the engine is brand new, do not put an excessive load on it for the first 1600 km (1000 mi). The various parts in the engine wear and polish themselves to the correct operating clearances. During this period, prolonged full-throttle operation or any condition that might result in engine overheating must be avoided.

EAU17094

### 0–1000 km (0–600 mi)

Avoid prolonged operation above 5000 r/min. **NOTICE: After 1000 km (600 mi) of operation, the engine oil must be changed and the oil filter cartridge or element replaced.** [ECA10303]

### 1000–1600 km (600–1000 mi)

Avoid prolonged operation above 6000 r/min.

## 1600 km (1000 mi) and beyond

The vehicle can now be operated normally.

ECA10311

### NOTICE

- **Keep the engine speed out of the tachometer red zone.**
- **If any engine trouble should occur during the engine break-in period, immediately have a Yamaha dealer check the vehicle.**

# Operation and important riding points

## Starting the engine

EAU93120

The ignition circuit cut-off system will enable starting when:

- the transmission is in the neutral position or
- the transmission is in gear, the sidestand is up, and the clutch lever is pulled.

### To start the engine

1. Turn the main switch on and set the engine stop switch to the run position.
2. Confirm the indicator and warning light(s) come on for a few seconds, and then go off. (See page 4-3.)

### **TIP**

- Do not start the engine if the engine trouble warning light remains on.
- The oil pressure warning light should come on and stay on until the engine is started.

- The ABS warning light should come on and stay on until the vehicle reaches a speed of 5 km/h (3 mi/h).

EAUM3632

ECA24110

### **NOTICE**

**If a warning or indicator light does not work as described above, have a Yamaha dealer check the vehicle.**

3. Shift the transmission into the neutral position.
4. Start the engine by pushing the start switch.
5. Release the start switch when the engine starts, or after 5 seconds. Wait 10 seconds before pressing the switch again to allow battery voltage to restore.

ECA11043

### **NOTICE**

**For maximum engine life, never accelerate hard when the engine is cold!**

### **TIP**

This model is equipped with:

- a lean angle sensor. This sensor stops the engine in case of a vehicle turnover. If this happens, the engine trouble warning light will come on, but this is not a malfunction. Turn the vehicle power off and then back on again to cancel the warning light. Failing to do so will prevent the engine from starting even though the engine will crank when pushing the start switch.
- an engine auto-stop system. The engine stops automatically if left idling for 20 minutes. If the engine stops, simply push the start switch to restart the engine.

EAUN0073

EAU16675

ECA10262

ECAN0072

## NOTICE

Do not ride through deep water, otherwise the engine may be damaged. Avoid puddles because they may be deeper than expected.

## Shifting

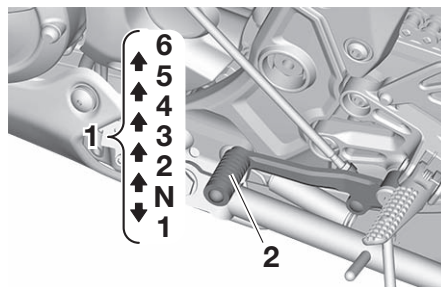

1. Gear positions
2. Shift pedal

Shifting gears lets you control the amount of engine power available for starting off, accelerating, climbing hills, etc.

The gear positions are shown in the illustration.

## TIP

To shift the transmission into the neutral position (N), press the shift pedal down repeatedly until it reaches the end of its travel, and then slightly raise it.

## NOTICE

- When shifting, press the shift pedal firmly until you feel the gear shift is complete.
- Even with the transmission in the neutral position, do not coast for long periods of time with the engine off, nor tow the motorcycle for long distances. The transmission is properly lubricated only when the engine is running. Inadequate lubrication may damage the transmission.
- Always use the clutch while changing gears to avoid damaging the engine, transmission, and drive train, which are not designed to withstand the shock of forced shifting.

6

EAU85370

## To start out and accelerate

1. Pull the clutch lever to disengage the clutch.
2. Shift the transmission into first gear. The neutral indicator light should go out.

# Operation and important riding points

---

3. Open the throttle gradually, and at the same time, release the clutch lever slowly.
4. After starting out, close the throttle, and at the same time, quickly pull the clutch lever in.
5. Shift the transmission into second gear. (Make sure not to shift the transmission into the neutral position.)
6. Open the throttle part way and gradually release the clutch lever.
7. Follow the same procedure when shifting to the next higher gear.

EAU85380

## To decelerate

1. Release the throttle and apply both the front and the rear brakes smoothly to slow the motorcycle.
2. As the vehicle decelerates, shift to a lower gear.
3. When the engine is about to stall or runs roughly, pull the clutch lever in, use the brakes to slow the motorcycle, and continue to downshift as necessary.

4. Once the motorcycle has stopped, the transmission can be shifted into the neutral position. The neutral indicator light should come on and then the clutch lever can be released.

EWA17380



- **Improper braking can cause loss of control or traction. Always use both brakes and apply them smoothly.**
  - **Make sure that the motorcycle and the engine have sufficiently slowed before shifting to a lower gear. Engaging a lower gear when the vehicle or engine speed is too high could make the rear wheel lose traction or the engine to over-rev. This could cause loss of control, an accident and injury. It could also cause engine or drive train damage.**
- 

EAU16811

## Tips for reducing fuel consumption

Fuel consumption depends largely on your riding style. Consider the following tips to reduce fuel consumption:

- Shift up swiftly, and avoid high engine speeds during acceleration.
- Do not rev the engine while shifting down, and avoid high engine speeds with no load on the engine.
- Turn the engine off instead of letting it idle for an extended length of time (e.g., in traffic jams, at traffic lights or at railroad crossings).

EAU17214

## Parking

When parking, stop the engine, and then remove the key from the main switch.

EWA10312

### **WARNING**

- **Since the engine and exhaust system can become very hot, park in a place where pedestrians or children are not likely to touch them and be burned.**
  - **Do not park on a slope or on soft ground, otherwise the vehicle may overturn, increasing the risk of a fuel leak and fire.**
  - **Do not park near grass or other flammable materials which might catch fire.**
-

# Periodic maintenance and adjustment

---

EAU17246

EWA15123

EAU17303

Periodic inspection, adjustment, and lubrication will keep your vehicle in the safest and most efficient condition possible. Safety is an obligation of the vehicle owner/operator. The most important points of vehicle inspection, adjustment, and lubrication are explained on the following pages.

The intervals given in the periodic maintenance charts should be simply considered as a general guide under normal riding conditions. However, depending on the weather, terrain, geographical location, and individual use, the maintenance intervals may need to be shortened.

## WARNING

EWA10322

**Failure to properly maintain the vehicle or performing maintenance activities incorrectly may increase your risk of injury or death during service or while using the vehicle. If you are not familiar with vehicle service, have a Yamaha dealer perform service.**

---

## WARNING

**Turn off the engine when performing maintenance unless otherwise specified.**

- **A running engine has moving parts that can catch on body parts or clothing and electrical parts that can cause shocks or fires.**
  - **Running the engine while servicing can lead to eye injury, burns, fire, or carbon monoxide poisoning – possibly leading to death. See page 2-3 for more information about carbon monoxide.**
- 

## WARNING

EWA15461

**Brake discs, calipers, drums, and linings can become very hot during use. To avoid possible burns, let brake components cool before touching them.**

---

Emission controls not only function to ensure cleaner air, but are also vital to proper engine operation and maximum performance. In the following periodic maintenance charts, the services related to emissions control are grouped separately. These services require specialized data, knowledge, and equipment. Maintenance, replacement, or repair of the emission control devices and systems may be performed by any repair establishment or individual that is certified (if applicable). Yamaha dealers are trained and equipped to perform these particular services.

## Tool kits

EAU85240

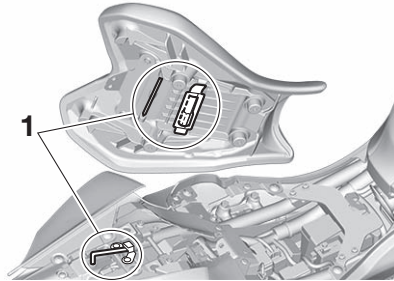

1. Tool kit

The on-board tool kit is in the location shown. Also, an additional tool kit was handed out separately at the time of vehicle purchase.

The information included in this manual and the tools provided in the tool kits are intended to assist you in the performance of preventive maintenance and minor repairs. However, a torque wrench and other tools are necessary to perform certain maintenance work correctly.

## TIP

If you do not have the tools or experience required for a particular job, have your Yamaha dealer perform it for you.

# Periodic maintenance and adjustment

EAU91891

## TIP

- The annual checks must be performed every year, except if a kilometer-based maintenance is performed instead.
- For 31000 km or 30 months, repeat the maintenance intervals starting from 7000 km or 6 months.
- Items marked with an asterisk require special tools, data and technical skills, have a Yamaha dealer perform the service.

EAU91902

## Periodic maintenance chart for the emission control system

No.	ITEM	ROUTINE	INITIAL	ODOMETER READINGS					ANNUAL CHECK
			1000 km or 1 month	7000 km or 6 months	13000 km or 12 months	19000 km or 18 months	25000 km or 24 months		
1	* Fuel line	<ul style="list-style-type: none"> <li>• Check fuel hoses for cracks or damage.</li> <li>• Replace if necessary.</li> </ul>		√	√	√	√	√	
2	* Spark plugs	<ul style="list-style-type: none"> <li>• Check condition.</li> <li>• Adjust gap and clean.</li> </ul>		√					
		<ul style="list-style-type: none"> <li>• Replace.</li> </ul>	Every 19000 km (12000 mi) or 18 months						
3	* Valve clearance	<ul style="list-style-type: none"> <li>• Check and adjust valve clearance when engine is cold.</li> </ul>	Every 42000 km (26600 mi)						
4	* Fuel injection	<ul style="list-style-type: none"> <li>• Check engine idle speed.</li> </ul>	√	√	√	√	√	√	
		<ul style="list-style-type: none"> <li>• Check and adjust synchronization.</li> </ul>		√	√	√	√	√	
5	* Exhaust system	<ul style="list-style-type: none"> <li>• Check for leakage.</li> <li>• Tighten if necessary.</li> <li>• Replace gasket(s) if necessary.</li> </ul>		√	√	√	√		



# Periodic maintenance and adjustment

No.	ITEM	ROUTINE	INITIAL	ODOMETER READINGS					ANNUAL CHECK
			1000 km or 1 month	7000 km or 6 months	13000 km or 12 months	19000 km or 18 months	25000 km or 24 months		
6	*	<b>Evaporative emission control system</b>	<ul style="list-style-type: none"> <li>• Check control system for damage.</li> <li>• Replace if necessary.</li> </ul>			√		√	

# Periodic maintenance and adjustment

EAU92131

## General maintenance and lubrication chart

No.	ITEM	ROUTINE	INITIAL	ODOMETER READINGS					ANNUAL CHECK
			1000 km or 1 month	7000 km or 6 months	13000 km or 12 months	19000 km or 18 months	25000 km or 24 months		
1	* Diagnostic system check	<ul style="list-style-type: none"> <li>Perform dynamic inspection using Yamaha diagnostic tool.</li> <li>Check the error codes.</li> </ul>	√	√	√	√	√	√	
2	* Air filter element	<ul style="list-style-type: none"> <li>Replace.</li> </ul>	Every 40000 km (24000 mi)						
3	Air filter check hose	<ul style="list-style-type: none"> <li>Clean.</li> </ul>	√	√	√	√	√		
4	Clutch	<ul style="list-style-type: none"> <li>Check operation.</li> <li>Adjust.</li> </ul>	√	√	√	√	√		
5	* Front brake	<ul style="list-style-type: none"> <li>Check operation, fluid level, and for fluid leakage.</li> <li>Replace brake pads if necessary.</li> </ul>	√	√	√	√	√	√	
6	* Rear brake	<ul style="list-style-type: none"> <li>Check operation, fluid level, and for fluid leakage.</li> <li>Replace brake pads if necessary.</li> </ul>	√	√	√	√	√	√	
7	* Brake hoses	<ul style="list-style-type: none"> <li>Check for cracks or damage.</li> <li>Check for correct routing and clamping.</li> </ul>		√	√	√	√	√	
		<ul style="list-style-type: none"> <li>Replace.</li> </ul>	Every 4 years						
8	* Brake fluid	<ul style="list-style-type: none"> <li>Change.</li> </ul>	Every 2 years						
9	* Wheels	<ul style="list-style-type: none"> <li>Check runout and for damage.</li> <li>Replace if necessary.</li> </ul>		√	√	√	√		
10	* Tires	<ul style="list-style-type: none"> <li>Check tread depth and for damage.</li> <li>Replace if necessary.</li> <li>Check air pressure.</li> <li>Correct if necessary.</li> </ul>		√	√	√	√	√	

# Periodic maintenance and adjustment

No.	ITEM	ROUTINE	INITIAL	ODOMETER READINGS					ANNUAL CHECK
			1000 km or 1 month	7000 km or 6 months	13000 km or 12 months	19000 km or 18 months	25000 km or 24 months		
11	* Wheel bearings	<ul style="list-style-type: none"> <li>Check bearings for looseness or damage.</li> </ul>		√	√	√	√		
12	* Swingarm	<ul style="list-style-type: none"> <li>Check operation and for excessive play.</li> </ul>		√	√	√	√		
		<ul style="list-style-type: none"> <li>Lubricate with lithium-soap-based grease.</li> </ul>	Every 50000 km (30000 mi)						
13	Drive chain	<ul style="list-style-type: none"> <li>Check chain slack, alignment and condition.</li> <li>Adjust and lubricate chain with a special O-ring chain lubricant thoroughly.</li> </ul>	Every 1000 km (600 mi) and after washing the motorcycle, riding in the rain or riding in wet areas						
14	* Steering bearings	<ul style="list-style-type: none"> <li>Check bearing assemblies for looseness.</li> </ul>	√	√	√	√	√		
		<ul style="list-style-type: none"> <li>Moderately repack with lithium-soap-based grease.</li> </ul>	Every 19000 km (12000 mi)						
15	* Chassis fasteners	<ul style="list-style-type: none"> <li>Make sure that all nuts, bolts and screws are properly tightened.</li> </ul>		√	√	√	√	√	
16	Brake lever pivot shaft	<ul style="list-style-type: none"> <li>Lubricate with silicone grease.</li> </ul>		√	√	√	√	√	
17	Brake pedal pivot shaft	<ul style="list-style-type: none"> <li>Lubricate with lithium-soap-based grease.</li> </ul>		√	√	√	√	√	
18	Clutch lever pivot shaft	<ul style="list-style-type: none"> <li>Lubricate with lithium-soap-based grease.</li> </ul>		√	√	√	√	√	
19	Shift pedal pivot shaft	<ul style="list-style-type: none"> <li>Lubricate with lithium-soap-based grease.</li> </ul>		√	√	√	√	√	

# Periodic maintenance and adjustment

No.	ITEM	ROUTINE	INITIAL	ODOMETER READINGS					ANNUAL CHECK
			1000 km or 1 month	7000 km or 6 months	13000 km or 12 months	19000 km or 18 months	25000 km or 24 months		
20	<b>Sidestand</b>	<ul style="list-style-type: none"> <li>• Check operation.</li> <li>• Lubricate with molybdenum disulfide grease.</li> </ul>		√	√	√	√	√	
21 *	<b>Sidestand switch</b>	<ul style="list-style-type: none"> <li>• Check operation and replace if necessary.</li> </ul>	√	√	√	√	√	√	
22 *	<b>Front fork</b>	<ul style="list-style-type: none"> <li>• Check operation and for oil leakage.</li> <li>• Replace if necessary.</li> </ul>		√	√	√	√		
23 *	<b>Shock absorber assembly</b>	<ul style="list-style-type: none"> <li>• Check operation and for oil leakage.</li> <li>• Replace if necessary.</li> </ul>		√	√	√	√		
24 *	<b>Rear suspension relay arm and connecting arm pivoting points</b>	<ul style="list-style-type: none"> <li>• Check operation.</li> </ul>		√	√	√	√		
		<ul style="list-style-type: none"> <li>• Lubricate with lithium-soap-based grease.</li> </ul>			√		√		
25	<b>Engine oil</b>	<ul style="list-style-type: none"> <li>• Change.</li> <li>• Check oil level and vehicle for oil leakage.</li> </ul>	√	√	√	√	√	√	
26	<b>Engine oil filter cartridge</b>	<ul style="list-style-type: none"> <li>• Replace.</li> </ul>	√		√		√		
27 *	<b>Cooling system</b>	<ul style="list-style-type: none"> <li>• Check coolant level and vehicle for coolant leakage.</li> </ul>		√	√	√	√	√	
		<ul style="list-style-type: none"> <li>• Change coolant.</li> </ul>	Every 3 years						
28 *	<b>Front and rear brake switches</b>	<ul style="list-style-type: none"> <li>• Check operation.</li> </ul>	√	√	√	√	√	√	

# Periodic maintenance and adjustment

No.	ITEM	ROUTINE	INITIAL	ODOMETER READINGS					ANNUAL CHECK
			1000 km or 1 month	7000 km or 6 months	13000 km or 12 months	19000 km or 18 months	25000 km or 24 months		
29	Control cables	<ul style="list-style-type: none"> <li>Apply Yamaha cable lubricant or other suitable cable lubricant thoroughly.</li> </ul>		√	√	√	√	√	
30	* Throttle grip	<ul style="list-style-type: none"> <li>Check operation.</li> <li>Check throttle grip free play, and adjust if necessary.</li> <li>Lubricate cable and grip housing.</li> </ul>		√	√	√	√	√	
31	* Lights, signals and switches	<ul style="list-style-type: none"> <li>Check operation.</li> <li>Adjust headlight beam.</li> </ul>	√	√	√	√	√	√	

EAU18681

7

## TIP

- Air filter
  - This model's air filter is equipped with a disposable oil-coated paper element, which must not be cleaned with compressed air to avoid damaging it.
  - The air filter element needs to be replaced more frequently when riding in unusually wet or dusty areas.
- Hydraulic brake service
  - Regularly check and, if necessary, correct the brake fluid level.
  - Every two years replace the internal components of the brake master cylinders and calipers, and change the brake fluid.
  - Replace the brake hoses every four years and if cracked or damaged.

# Periodic maintenance and adjustment

## Removing and installing cowlings

EAU18782

The cowlings shown need to be removed to perform some of the maintenance jobs described in this chapter. Refer to this section each time a cowling needs to be removed and installed.

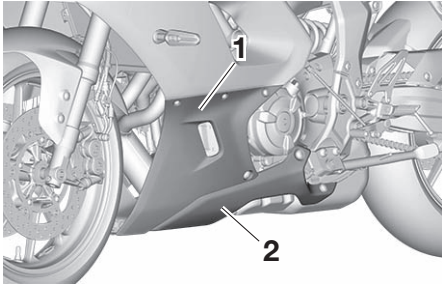

1. Cowling A
2. Cowling B

## Cowling A and B

EAU93130

### To remove the cowling

1. Remove the bolts, washers and the quick fastener screws, and then pull cowling A off as shown.

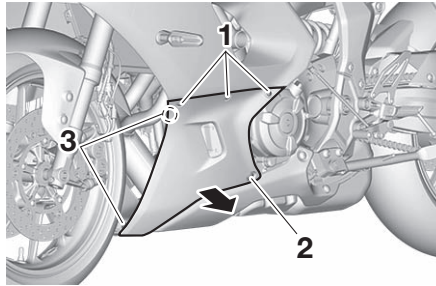

1. Bolt and washer
2. Bolt
3. Quick fastener screw

2. Remove the bolts and nut, and then pull cowling B off as shown.

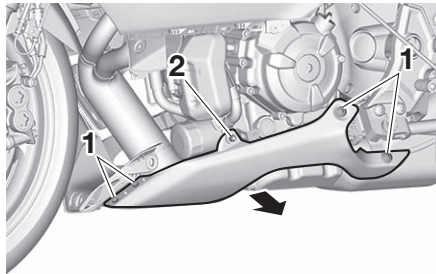

1. Bolt
2. Nut

### To install the cowling

1. Place cowling B in its original position, and then install the bolts and nut.
2. Fit the upper projections into the slots, and then place cowling A in its original position.

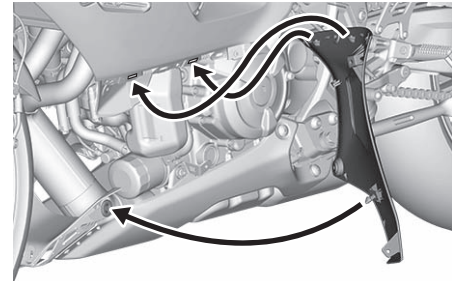

3. Install the bolts, washers and the quick fastener screws.

# Periodic maintenance and adjustment

## Checking the spark plugs

EAU19653

The spark plugs are important engine components, which should be checked periodically, preferably by a Yamaha dealer. Since heat and deposits will cause any spark plug to slowly erode, they should be removed and checked in accordance with the periodic maintenance and lubrication chart. In addition, the condition of the spark plugs can reveal the condition of the engine.

The porcelain insulator around the center electrode of each spark plug should be a medium-to-light tan (the ideal color when the vehicle is ridden normally), and all spark plugs installed in the engine should have the same color. If any spark plug shows a distinctly different color, the engine could be operating improperly. Do not attempt to diagnose such problems yourself. Instead, have a Yamaha dealer check the vehicle.

If a spark plug shows signs of electrode erosion and excessive carbon or other deposits, it should be replaced.

**Specified spark plug:**  
NGK/LMAR8A-9

Before installing a spark plug, the spark plug gap should be measured with a wire thickness gauge and, if necessary, adjusted to specification.

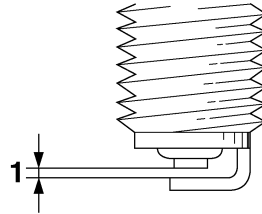

1. Spark plug gap

**Spark plug gap:**  
0.8–0.9 mm (0.031–0.035 in)

Clean the surface of the spark plug gasket and its mating surface, and then wipe off any grime from the spark plug threads.

**Tightening torque:**  
Spark plug:  
13 N·m (1.3 kgf·m, 9.6 lb·ft)

## TIP

If a torque wrench is not available when installing a spark plug, a good estimate of the correct torque is 1/4–1/2 turn past finger tight. However, the spark plug should be tightened to the specified torque as soon as possible.

ECA10841

## NOTICE

**Do not use any tools to remove or install the spark plug cap, otherwise the ignition coil coupler may get damaged. The spark plug cap may be difficult to remove because the rubber seal on the end of the cap fits tightly. To remove the spark plug cap, simply twist it back and forth while pulling it out; to install it, twist it back and forth while pushing it in.**

# Periodic maintenance and adjustment

## Canister

EAU36113

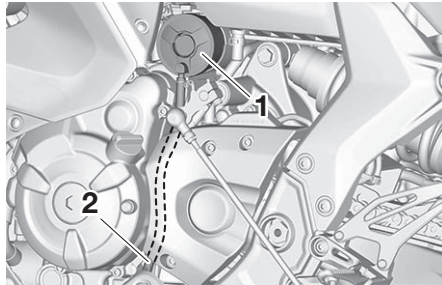

1. Canister
2. Canister breather hose

7

This model is equipped with a canister to prevent the discharging of fuel vapor into the atmosphere. Before operating this vehicle, make sure to check the following:

- Check each hose connection.
- Check each hose and canister for cracks or damage. Replace if damaged.
- Make sure that the canister breather is not blocked, and if necessary, clean it.

## Engine oil and oil filter cartridge

EAU93141

The engine oil level should be checked before each ride. In addition, the oil must be changed and the oil filter cartridge replaced at the intervals specified in the periodic maintenance and lubrication chart.

### To check the engine oil level

1. Place the vehicle on a level surface and hold it in an upright position. A slight tilt to the side can result in a false reading.
2. Start the engine, warm it up for several minutes, and then turn it off.
3. Wait a few minutes for the oil level to settle for an accurate reading, and then check the oil level through the engine oil level check window located at the bottom-left side of the crankcase.

### TIP

The engine oil should be between the minimum and maximum level marks.

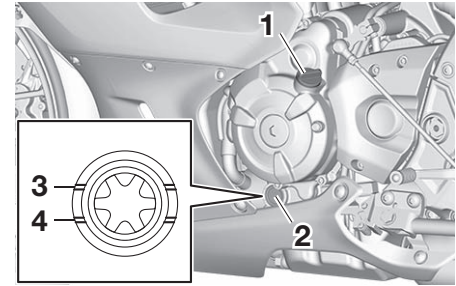

1. Engine oil filler cap
2. Engine oil level check window
3. Maximum level mark
4. Minimum level mark

4. If the engine oil is below the minimum level mark, add sufficient oil of the recommended type to raise it to the correct level.

### TIP

Check the O-ring for damage, and replace it if necessary.



# Periodic maintenance and adjustment

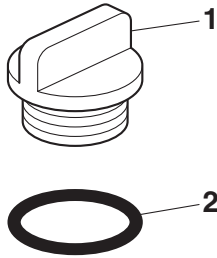

1. Engine oil filler cap
2. O-ring

## To change the engine oil (with or without oil filter cartridge replacement)

1. Place the vehicle on a level surface.
2. Remove cowling A and B. (See page 7-9.)
3. Start the engine, warm it up for several minutes, and then turn it off.
4. Place an oil pan under the engine to collect the used oil.
5. Remove the engine oil filler cap, the engine oil drain bolt and its gasket to drain the oil from the crankcase.

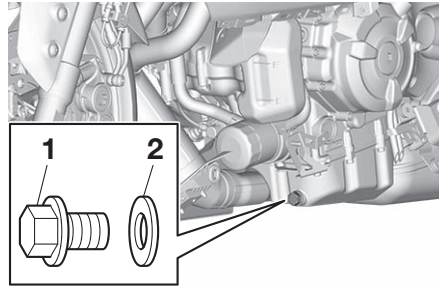

1. Engine oil drain bolt
2. Gasket

**TIP** Skip steps 6–8 if the oil filter cartridge is not being replaced.

6. Remove the oil filter cartridge with an oil filter wrench.

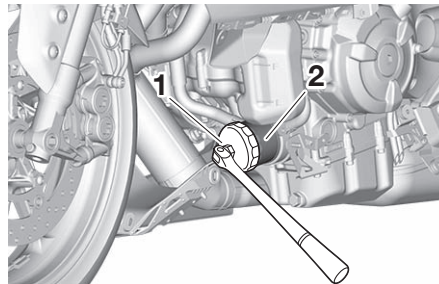

1. Oil filter wrench
2. Oil filter cartridge

**TIP** An oil filter wrench is available at a Yamaha dealer.

7. Apply a thin coat of clean engine oil to the O-ring of the new oil filter cartridge.

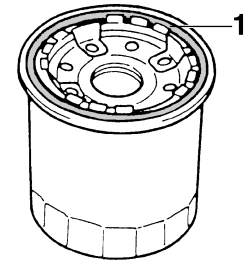

1. O-ring

**TIP** Make sure that the O-ring is properly seated.

8. Install the new oil filter cartridge with an oil filter wrench, and then tighten it to the specified torque with a torque wrench.

# Periodic maintenance and adjustment

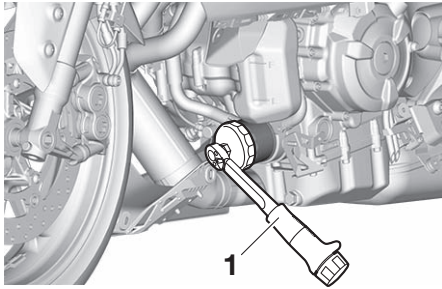

1. Torque wrench

## Tightening torque:

Oil filter cartridge:  
17 N·m (1.7 kgf·m, 13 lb·ft)

9. Install the engine oil drain bolt and its new gasket, and then tighten the bolt to the specified torque.

## Tightening torque:

Engine oil drain bolt:  
43 N·m (4.3 kgf·m, 32 lb·ft)

10. Refill with the specified amount of the recommended engine oil.

## Recommended engine oil:

See page 9-1.

## Oil quantity:

Oil change:

2.30 L (2.43 US qt, 2.02 Imp.qt)

With oil filter removal:

2.60 L (2.75 US qt, 2.29 Imp.qt)

## TIP

Be sure to wipe off spilled oil on any parts after the engine and exhaust system have cooled down.

ECA11621

## NOTICE

- **In order to prevent clutch slippage (since the engine oil also lubricates the clutch), do not mix any chemical additives. Do not use oils with a diesel specification of “CD” or oils of a higher quality than specified. In addition, do not use oils labeled “ENERGY CONSERVING II” or higher.**
- **Make sure that no foreign material enters the crankcase.**

11. Check the O-ring for damage, and replace it if necessary.

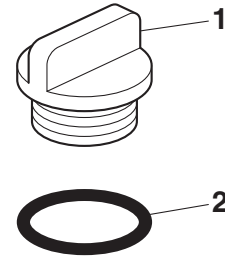

1. Engine oil filler cap  
2. O-ring

12. Install and tighten the engine oil filler cap.
13. Start the engine, and then let it idle for several minutes while checking it for oil leakage. If oil is leaking, immediately turn the engine off and check for the cause.

## TIP

After the engine is started, the engine oil pressure warning light should go off.

ECA20860

## NOTICE

**If the oil pressure warning light flickers or remains on even if the oil level is correct, immediately turn the engine off and have a Yamaha dealer check the vehicle.**

14. Turn the engine off, wait a few minutes for the oil level to settle for an accurate reading, and then check the oil level and correct it if necessary.
15. Install the cowlings.

## Why Yamalube

YAMALUBE oil is a Genuine YAMAHA Part born of the engineers' passion and belief that engine oil is an important liquid engine component. We form teams of specialists in the fields of mechanical engineering, chemistry, electronics and track testing, and have them develop the engine together with the oil it will use. Yamalube oils take full advantage of the base oil's qualities and blend in the ideal balance of additives to make sure the final oil clears our performance standards. Thus, Yamalube mineral, semisynthetic and synthetic oils have their own distinct characters and value. Yamaha's experience gained over many years of research and development into oil since the 1960's helps make Yamalube the best choice for your Yamaha engine.



EAU85450

## Coolant

The coolant level should be checked regularly. In addition, the coolant must be changed at the intervals specified in the periodic maintenance chart.

### Recommended coolant:

YAMALUBE coolant

### Coolant quantity:

Coolant reservoir (max level mark):  
0.25 L (0.26 US qt, 0.22 Imp.qt)  
Radiator (including all routes):  
1.60 L (1.69 US qt, 1.41 Imp.qt)

## TIP

If genuine Yamaha coolant is not available, use an ethylene glycol antifreeze containing corrosion inhibitors for aluminum engines and mix with distilled water at a 1:1 ratio.

EAU20097

## To check the coolant level

Since the coolant level varies with engine temperature, check when the engine is cold.

1. Park the vehicle on a level surface.

# Periodic maintenance and adjustment

2. With the vehicle in an upright position, look at the coolant level in the reservoir.

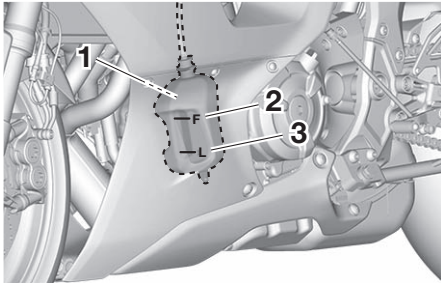

1. Coolant reservoir
2. Maximum level mark
3. Minimum level mark

3. If the coolant is at or below the minimum level mark, remove the coolant reservoir cap. **WARNING! Remove only the coolant reservoir cap. Never attempt to remove the radiator cap when the engine is hot.** [EWA15162]

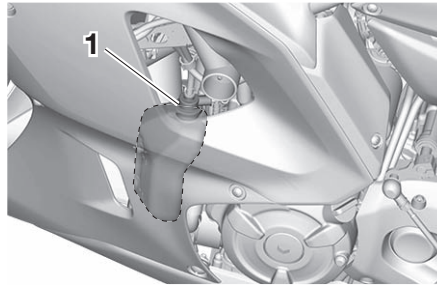

1. Coolant reservoir cap

4. Add coolant to the maximum level mark. **NOTICE: If coolant is not available, use distilled water or soft tap water instead. Do not use hard water or salt water since it is harmful to the engine. If water has been used instead of coolant, replace it with coolant as soon as possible, otherwise the cooling system will not be protected against frost and corrosion. If water has been added to the coolant, have a Yamaha dealer check the anti-freeze content of the coolant as soon as possible, otherwise the effectiveness of the coolant will be reduced.** [ECA10473]

5. Install the coolant reservoir cap.

EAU33032

## Changing the coolant

The coolant must be changed at the intervals specified in the periodic maintenance and lubrication chart. Have a Yamaha dealer change the coolant. **WARNING! Never attempt to remove the radiator cap when the engine is hot.** [EWA10382]

## Replacing the air filter element and cleaning the check hose

EAU60451

The air filter element should be replaced at the intervals specified in the periodic maintenance and lubrication chart. Have a Yamaha dealer replace the air filter element more frequently if you are riding in unusually wet or dusty areas. However, the air filter check hose can be easily reached and should be frequently checked and cleaned if necessary.

### To clean the air filter check hose

1. Remove the air filter check hose under the air filter case.

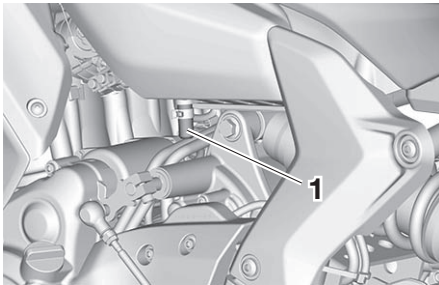

1. Air filter check hose

2. Clean and then install the hose.

## Checking the engine idling speed

EAU44735

Check the engine idling speed and, if necessary, have it corrected by a Yamaha dealer.

**Engine idling speed:**  
1250–1450 r/min

# Periodic maintenance and adjustment

## Checking the throttle grip free play

EAU21386

Measure the throttle grip free play as shown.

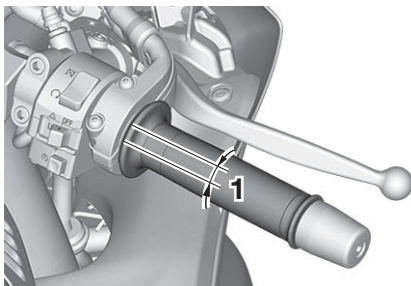

1. Throttle grip free play

**Throttle grip free play:**  
3.0–5.0 mm (0.12–0.20 in)

Periodically check the throttle grip free play and, if necessary, have a Yamaha dealer adjust it.

## Valve clearance

EAU21403

The valves are an important engine component, and since valve clearance changes with use, they must be checked and adjusted at the intervals specified in the periodic maintenance chart. Unadjusted valves can result in improper air-fuel mixture, engine noise, and eventually engine damage. To prevent this from occurring, have your Yamaha dealer check and adjust the valve clearance at regular intervals.

### TIP

This service must be performed when the engine is cold.

## Tires

EAU69793

Tires are the only contact between the vehicle and the road. Safety in all conditions of riding depends on a relatively small area of road contact. Therefore, it is essential to maintain the tires in good condition at all times and replace them at the appropriate time with the specified tires.

### Tire air pressure

The tire air pressure should be checked and, if necessary, adjusted before each ride.

EWA10504

### **WARNING**

Operation of this vehicle with improper tire pressure may cause severe injury or death from loss of control.

- The tire air pressure must be checked and adjusted on cold tires (i.e., when the temperature of the tires equals the ambient temperature).
- The tire air pressure must be adjusted in accordance with the riding speed and with the total

# Periodic maintenance and adjustment

weight of rider, passenger, cargo, and accessories approved for this model.

## Cold tire air pressure:

### 1 person:

Front:

250 kPa (2.50 kgf/cm<sup>2</sup>, 36 psi)

Rear:

290 kPa (2.90 kgf/cm<sup>2</sup>, 42 psi)

### 2 persons:

Front:

250 kPa (2.50 kgf/cm<sup>2</sup>, 36 psi)

Rear:

290 kPa (2.90 kgf/cm<sup>2</sup>, 42 psi)

## Maximum load:

Vehicle:

162 kg (357 lb)

The vehicle's maximum load is the combined weight of the rider, passenger, cargo, and any accessories.

EWA10512



## WARNING

Never overload your vehicle. Operation of an overloaded vehicle could cause an accident.

## Tire inspection

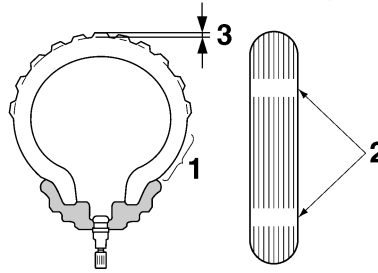

1. Tire sidewall
2. Tire wear indicator
3. Tire tread depth

The tires must be checked before each ride. If the tire shows crosswise lines (minimum tread depth), if the tire has a nail or glass fragments in it, or if the sidewall is cracked, have a Yamaha dealer replace the tire immediately.

## Minimum tire tread depth (front and rear):

1.0 mm (0.04 in)

EWA10472



## WARNING

- Have a Yamaha dealer replace excessively worn tires. Besides being illegal, operating the vehi-

cle with excessively worn tires decreases riding stability and can lead to loss of control.

- The replacement of all wheel and brake-related parts, including the tires, should be left to a Yamaha dealer, who has the necessary professional knowledge and experience to do so.
- Ride at moderate speeds after changing a tire since the tire surface must first be "broken in" for it to develop its optimal characteristics.

## Tire information

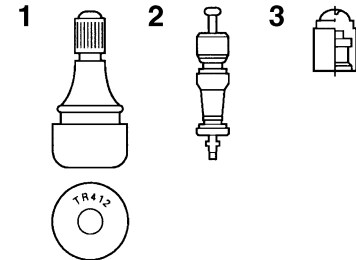

1. Tire air valve
2. Tire air valve core
3. Tire air valve cap with seal

# Periodic maintenance and adjustment

This model is equipped with tubeless tires and tire air valves.

Tires age, even if they have not been used or have only been used occasionally. Cracking of the tread and sidewall rubber, sometimes accompanied by carcass deformation, is an evidence of aging. Old and aged tires shall be checked by tire specialists to ascertain their suitability for further use.

EWA10482

## WARNING

- The front and rear tires should be of the same make and design, otherwise the handling characteristics of the motorcycle may be different, which could lead to an accident.
- Always make sure that the valve caps are securely installed to prevent air pressure leakage.
- Use only the tire valves and valve cores listed below to avoid tire deflation during a high-speed ride.

After extensive tests, only the tires listed below have been approved for this model by Yamaha.

### Front tire:

Size:

120/70ZR17M/C (58W)

Manufacturer/model:

BRIDGESTONE/BATTLAX  
HYPERSPORT S22F

### Rear tire:

Size:

180/55ZR17M/C (73W)

Manufacturer/model:

BRIDGESTONE/BATTLAX  
HYPERSPORT S22R

### FRONT and REAR:

Tire air valve:

TR412

Valve core:

#9100 (original)

EWA10601

## WARNING

This motorcycle is fitted with super-high-speed tires. Note the following points in order to make the most efficient use of these tires.

- Use only the specified replacement tires. Other tires may run the danger of bursting at super high speeds.
- Brand-new tires can have a relatively poor grip on certain road surfaces until they have been

“broken in”. Therefore, it is advisable before doing any high-speed riding to ride conservatively for approximately 100 km (60 mi) after installing a new tire.

- The tires must be warmed up before a high-speed run.
- Always adjust the tire air pressure according to the operating conditions.



## Cast wheels

EAU21963

To maximize the performance, durability, and safe operation of your vehicle, note the following points regarding the specified wheels.

- The wheel rims should be checked for cracks, bends, warpage or other damage before each ride. If any damage is found, have a Yamaha dealer replace the wheel. Do not attempt even the smallest repair to the wheel. A deformed or cracked wheel must be replaced.
- The wheel should be balanced whenever either the tire or wheel has been changed or replaced. An unbalanced wheel can result in poor performance, adverse handling characteristics, and a shortened tire life.

## Adjusting the clutch lever free play

EAU22083

Measure the clutch lever free play as shown.

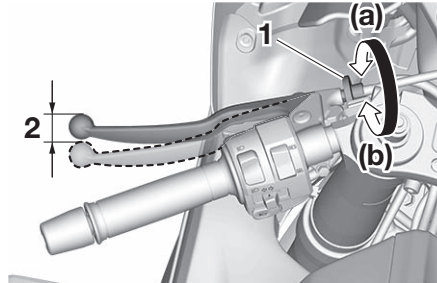

1. Clutch lever free play adjusting bolt
2. Clutch lever free play

**Clutch lever free play:**  
5.0–10.0 mm (0.20–0.39 in)

Periodically check the clutch lever free play and, if necessary, adjust it as follows.

To increase the clutch lever free play, turn the clutch lever free play adjusting bolt in direction (a). To decrease the clutch lever free play, turn the adjusting bolt in direction (b).

## TIP

If the specified free play cannot be obtained as described above or if the clutch does not operate correctly, have a Yamaha dealer check the internal clutch mechanism.

# Periodic maintenance and adjustment

## Checking the brake lever free play

EAU37914

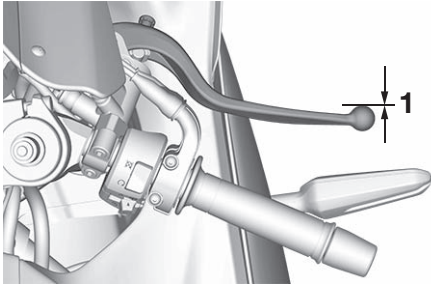

1. No brake lever free play

7

There should be no free play at the brake lever end. If there is free play, have a Yamaha dealer inspect the brake system.

EWA14212

### **⚠ WARNING**

**A soft or spongy feeling in the brake lever can indicate the presence of air in the hydraulic system. If there is air in the hydraulic system, have a Yamaha dealer bleed the system before operating the vehicle. Air in the hydraulic system will diminish the**

**braking performance, which may result in loss of control and an accident.**

---

## Brake light switches

EAU36505

The brake light should come on just before braking takes effect. The brake light is activated by switches connected to the brake lever and brake pedal. Since the brake light switches are components of the anti-lock brake system, they should only be serviced by a Yamaha dealer.

## Checking the front and rear brake pads

EAU22393

The front and rear brake pads must be checked for wear at the intervals specified in the periodic maintenance and lubrication chart.

### Front brake pads

EAU36892

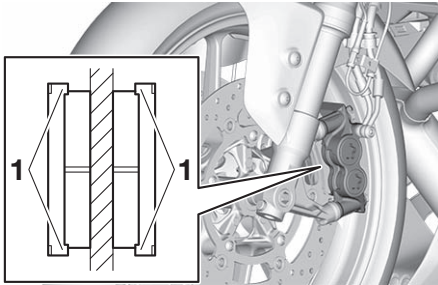

1. Brake pad wear indicator

Each front brake pad is provided with wear indicators, which allows you to check the brake pad wear without having to disassemble the brake. To check the brake pad wear, check the position of the wear indicators while applying the brake. If a brake pad has worn to the point that a wear indicator almost

touches the brake disc, have a Yamaha dealer replace the brake pads as a set.

### Rear brake pads

EAU46292

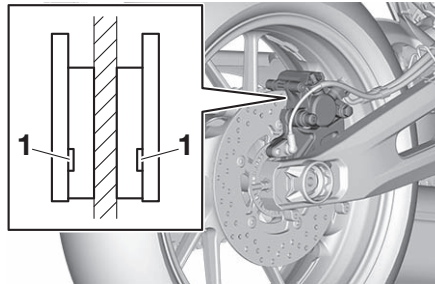

1. Brake pad wear indicator groove

Each rear brake pad is provided with wear indicator grooves, which allow you to check the brake pad wear without having to disassemble the brake. To check the brake pad wear, check the wear indicator grooves. If a brake pad has worn to the point that a wear indicator groove almost appears, have a Yamaha dealer replace the brake pads as a set.

## Checking the brake fluid level

EAU66670

Before riding, check that the brake fluid is above the minimum level mark. Check the brake fluid level with the top of the reservoir level. Replenish the brake fluid if necessary.

### Front brake

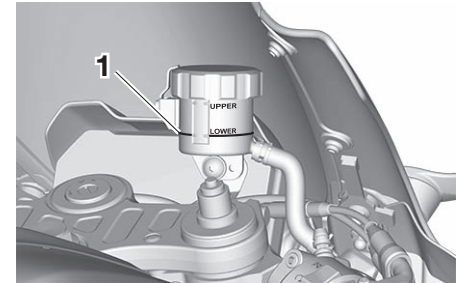

1. Minimum level mark

# Periodic maintenance and adjustment

## Rear brake

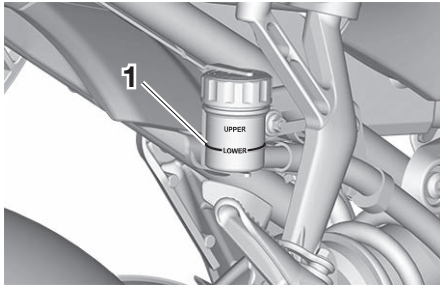

1. Minimum level mark

### Specified brake fluid:

YAMAHA GENUINE BRAKE FLUID  
(DOT 4)

EWA16011

### **WARNING**

Improper maintenance can result in loss of braking ability. Observe these precautions:

- Insufficient brake fluid may allow air to enter the brake system, reducing braking performance.
- Clean the filler cap before removing. Use only DOT 4 brake fluid from a sealed container.

- Use only the specified brake fluid; otherwise, the rubber seals may deteriorate, causing leakage.
- Refill with the same type of brake fluid. Adding a brake fluid other than DOT 4 may result in a harmful chemical reaction.
- Be careful that water or dust does not enter the brake fluid reservoir when refilling. Water will significantly lower the boiling point of the fluid and may result in vapor lock, and dirt may clog the ABS hydraulic unit valves.

fluid level goes down suddenly, have a Yamaha dealer check the cause before further riding.

ECA17641

### **NOTICE**

Brake fluid may damage painted surfaces or plastic parts. Always clean up spilled fluid immediately.

As the brake pads wear, it is normal for the brake fluid level to gradually go down. A low brake fluid level may indicate worn brake pads and/or brake system leakage; therefore, be sure to check the brake pads for wear and the brake system for leakage. If the brake

## Changing the brake fluid

EAU22734

Have a Yamaha dealer change the brake fluid every 2 years. In addition, have the seals of the master cylinders and brake calipers, as well as the brake hoses replaced at the intervals listed below or sooner if they are damaged or leaking.

- Brake seals: every 2 years
- Brake hoses: every 4 years

## Drive chain slack

EAU22762

The drive chain slack should be checked before each ride and adjusted if necessary.

### To check the drive chain slack

EAU60046

1. Place the motorcycle on the side-stand.

### TIP \_\_\_\_\_

When checking and adjusting the drive chain slack, there should be no weight on the motorcycle.

2. Shift the transmission into the neutral position.
3. Push down on the drive chain under the end of the drive chain guard.
4. Measure distance A between the drive chain guard and the center of the chain as shown.

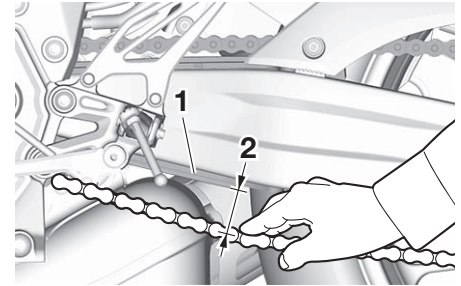

1. Drive chain guard
2. Distance A

### Distance A:

45.0–50.0 mm (1.77–1.97 in)

5. If distance A is incorrect, adjust it as follows. **NOTICE: Improper drive chain slack will overload the engine as well as other vital parts of the motorcycle and can lead to chain slippage or breakage. If distance A is more than 55.0 mm (2.17 in), the chain can damage the frame, swingarm, and other parts. To prevent this from occurring, keep the drive chain slack within the specified limits.** [ECA23070]

# Periodic maintenance and adjustment

EAU59921

## To adjust the drive chain slack

Consult a Yamaha dealer before adjusting the drive chain slack.

1. Loosen the locknut at each end of the swingarm, and then loosen the axle nut.

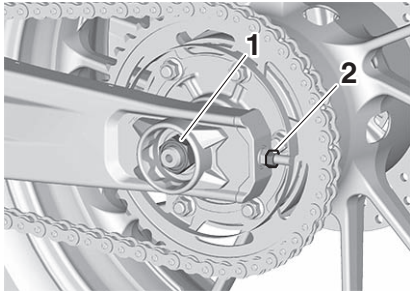

1. Axle nut
2. Locknut

2. To tighten the drive chain, turn the drive chain slack adjusting nut at each end of the swingarm in direction (a). To loosen the drive chain, turn the adjusting nut at each end of the swingarm in direction (b), and then push the rear wheel forward.

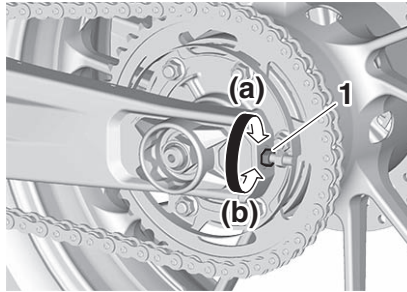

1. Drive chain slack adjusting nut

## TIP

Using the alignment marks on each side of the swingarm, make sure that both drive chain slack adjusting plates are in the same position for proper wheel alignment.

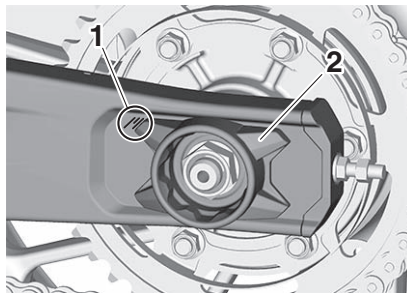

1. Alignment marks
2. Drive chain slack adjusting plate

3. Tighten the axle nut, and then tighten the locknuts to the specified torques.

## Tightening torques:

Axle nut:

105 N·m (10.5 kgf·m, 77 lb·ft)

Locknut:

16 N·m (1.6 kgf·m, 12 lb·ft)

4. Make sure that the drive chain slack adjusting plates are in the same position, the drive chain slack is correct, and the drive chain moves smoothly.

## Cleaning and lubricating the drive chain

EAU23027

The drive chain must be cleaned and lubricated at the intervals specified in the periodic maintenance and lubrication chart, otherwise it will quickly wear out, especially when riding in dusty or wet areas. Service the drive chain as follows.

ECA10584

### **NOTICE**

**The drive chain must be lubricated after washing the motorcycle, riding in the rain or riding in wet areas.**

1. Clean the drive chain with a drive chain cleaner and a small soft brush. **NOTICE: To prevent damaging the O-rings, do not clean the drive chain with steam cleaners, high-pressure washers or inappropriate solvents.**

[ECA11122]

2. Wipe the drive chain dry.
3. Thoroughly lubricate the drive chain with a special O-ring chain lubricant. **NOTICE: Do not use engine oil or any other lubri-**

**cants for the drive chain, as they may contain substances that could damage the O-rings.**

[ECA11112]

## Checking and lubricating the cables

EAU23098

The operation of all control cables and the condition of the cables should be checked before each ride, and the cables and cable ends should be lubricated if necessary. If a cable is damaged or does not move smoothly, have a Yamaha dealer check or replace it. **WARNING! Damage to the outer housing of cables may result in internal rusting and cause interference with cable movement. Replace damaged cables as soon as possible to prevent unsafe conditions.** [EWA10712]

### **Recommended lubricant:**

Yamaha cable lubricant or other suitable cable lubricant

# Periodic maintenance and adjustment

## Checking and lubricating the throttle grip and cable

EAU23115

The operation of the throttle grip should be checked before each ride. In addition, the cable should be lubricated by a Yamaha dealer at the intervals specified in the periodic maintenance chart.

The throttle cable is equipped with a rubber cover. Make sure that the cover is securely installed. Even though the cover is installed correctly, it does not completely protect the cable from water entry. Therefore, use care not to pour water directly onto the cover or cable when washing the vehicle. If the cable or cover becomes dirty, wipe clean with a moist cloth.

## Checking and lubricating the brake and shift pedals

EAU44276

The operation of the brake and shift pedals should be checked before each ride, and the pedal pivots should be lubricated if necessary.

### Brake pedal

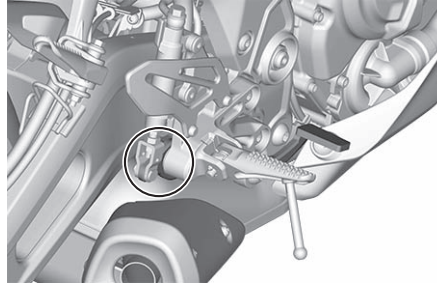

### Shift pedal

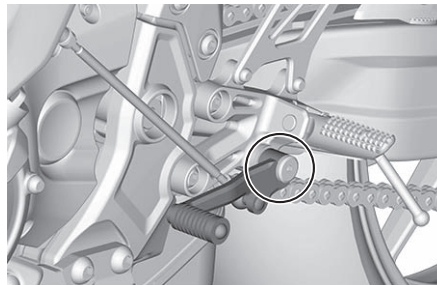

**Recommended lubricant:**  
Lithium-soap-based grease



# Periodic maintenance and adjustment

## Checking and lubricating the brake and clutch levers EAU23144

The operation of the brake and clutch levers should be checked before each ride, and the lever pivots should be lubricated if necessary.

### Brake lever

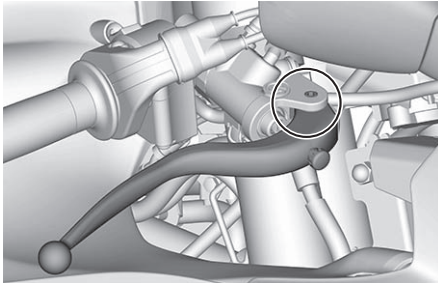

### Clutch lever

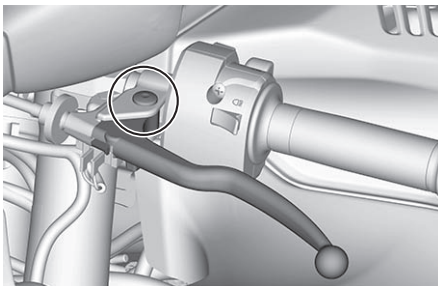

### Recommended lubricants:

- Brake lever:
  - Silicone grease
- Clutch lever:
  - Lithium-soap-based grease

## Checking and lubricating the sidestand EAU89101

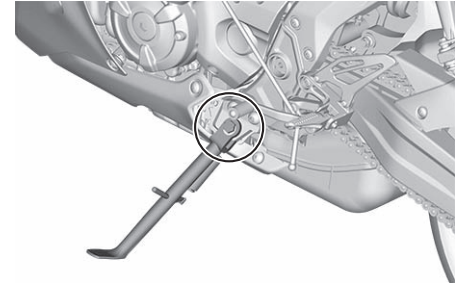

The operation of the sidestand should be checked before each ride, and the sidestand pivot and metal-to-metal contact surfaces should be lubricated if necessary.

7

### **WARNING**

If the sidestand does not move up and down smoothly, have a Yamaha dealer check or repair it. Otherwise, the sidestand could contact the ground and distract the operator, resulting in a possible loss of control.

- Recommended lubricant:
  - Molybdenum disulfide grease

# Periodic maintenance and adjustment

## Lubricating the rear suspension

EAU23252

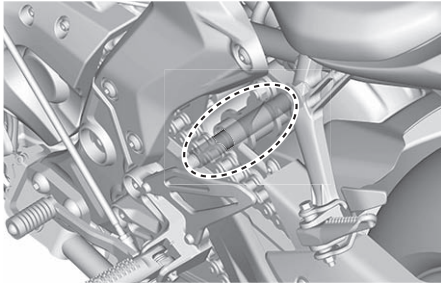

The pivoting points of the rear suspension must be lubricated by a Yamaha dealer at the intervals specified in the periodic maintenance and lubrication chart.

**Recommended lubricant:**  
Lithium-soap-based grease

## Lubricating the swingarm pivots

EAUM1653

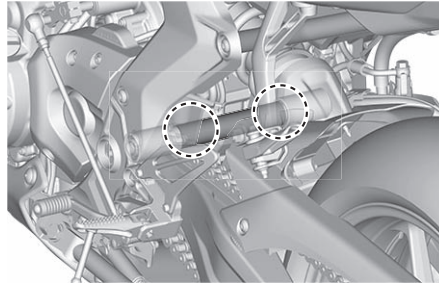

The swingarm pivots must be lubricated by a Yamaha dealer at the intervals specified in the periodic maintenance and lubrication chart.

**Recommended lubricant:**  
Lithium-soap-based grease

## Checking the front fork

EAU23273

The condition and operation of the front fork must be checked as follows at the intervals specified in the periodic maintenance and lubrication chart.

### To check the condition

Check the inner tubes for scratches, damage and excessive oil leakage.

### To check the operation

1. Place the vehicle on a level surface and hold it in an upright position. **WARNING! To avoid injury, securely support the vehicle so there is no danger of it falling over.** [EWA10752]
2. While applying the front brake, push down hard on the handlebars several times to check if the front fork compresses and rebounds smoothly.

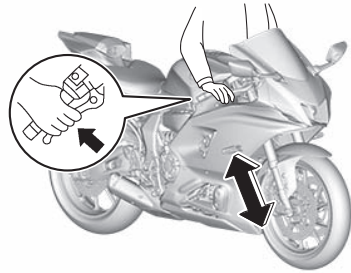

ECA10591

## NOTICE

If any damage is found or the front fork does not operate smoothly, have a Yamaha dealer check or repair it.

## Checking the steering

EAU23285

Worn or loose steering bearings may cause danger. Therefore, the operation of the steering must be checked as follows at the intervals specified in the periodic maintenance and lubrication chart.

1. Raise the front wheel off the ground. (See page 7-34.)  
**WARNING! To avoid injury, securely support the vehicle so there is no danger of it falling over.** [EWA10752]
2. Hold the lower ends of the front fork legs and try to move them forward and backward. If any free play can be felt, have a Yamaha dealer check or repair the steering.

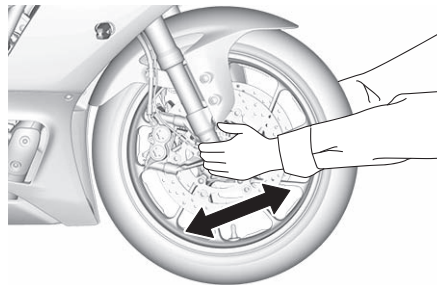

7-30

## Checking the wheel bearings

EAU23292

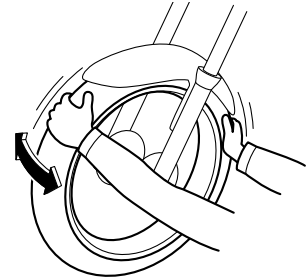

The front and rear wheel bearings must be checked at the intervals specified in the periodic maintenance and lubrication chart. If there is play in the wheel hub or if the wheel does not turn smoothly, have a Yamaha dealer check the wheel bearings.

# Periodic maintenance and adjustment

## Battery

EAU50212

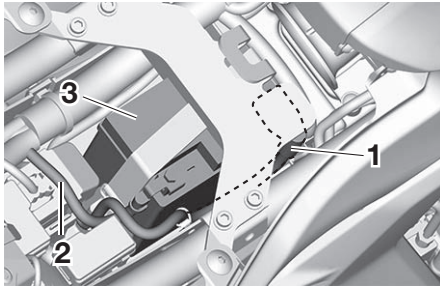

1. Positive battery lead (red)
2. Negative battery lead (black)
3. Battery

The battery is located under the rider seat. (See page 4-18.)

This model is equipped with a VRLA (Valve Regulated Lead Acid) battery. There is no need to check the electrolyte or to add distilled water. However, the battery lead connections need to be checked and, if necessary, tightened.

EWA10761

### **WARNING**

- **Electrolyte is poisonous and dangerous since it contains sulfuric acid, which causes severe**

burns. Avoid any contact with skin, eyes or clothing and always shield your eyes when working near batteries. In case of contact, administer the following FIRST AID.

- **EXTERNAL:** Flush with plenty of water.
- **INTERNAL:** Drink large quantities of water or milk and immediately call a physician.
- **EYES:** Flush with water for 15 minutes and seek prompt medical attention.
- **Batteries produce explosive hydrogen gas. Therefore, keep sparks, flames, cigarettes, etc., away from the battery and provide sufficient ventilation when charging it in an enclosed space.**
- **KEEP THIS AND ALL BATTERIES OUT OF THE REACH OF CHILDREN.**

### **To charge the battery**

Have a Yamaha dealer charge the battery as soon as possible if it seems to have discharged. Keep in mind that the

battery tends to discharge more quickly if the vehicle is equipped with optional electrical accessories.

ECA16522

### **NOTICE**

**To charge a VRLA (Valve Regulated Lead Acid) battery, a special (constant-voltage) battery charger is required. Using a conventional battery charger will damage the battery.**

### **To store the battery**

1. If the vehicle will not be used for more than one month, remove the battery, fully charge it, and then place it in a cool, dry place. **NOTICE: When removing the battery, be sure to turn the main switch off, then disconnect the negative lead before disconnecting the positive lead.** [ECA16304]
2. If the battery will be stored for more than two months, check it at least once a month and fully charge it if necessary.
3. Fully charge the battery before installation. **NOTICE: When installing the battery, be sure to turn the main switch off, then con-**

# Periodic maintenance and adjustment

nect the positive lead before connecting the negative lead.

[ECA16842]

4. After installation, make sure that the battery leads are properly connected to the battery terminals.

ECA16531

## NOTICE

**Always keep the battery charged. Storing a discharged battery can cause permanent battery damage.**

## Replacing the fuses

EAU59876

The main fuse and the fuse boxes, which contain the fuses for the individual circuits, are located under the rider seat. (See page 4-18.)

### TIP

To access the main fuse, remove the starter relay cover as shown.

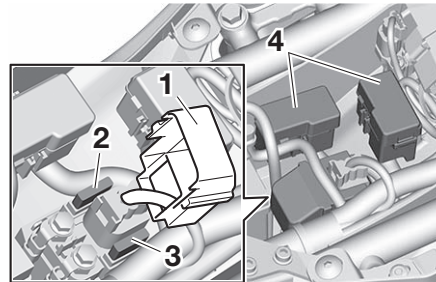

1. Starter relay cover
2. Main fuse
3. Spare main fuse
4. Fuse box

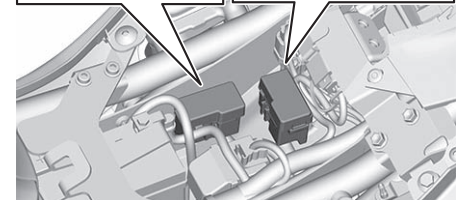
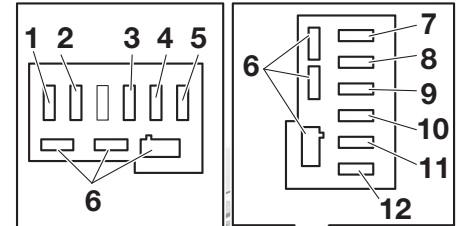

1. ABS solenoid fuse
2. ABS motor fuse
3. Accessory fuse
4. ABS ECU fuse
5. Terminal fuse 1
6. Spare fuse
7. Ignition fuse
8. Signaling system fuse
9. Headlight fuse
10. Fuel injection system fuse
11. Backup fuse (for clock and immobilizer system)
12. Radiator fan motor fuse

If a fuse is blown, replace it as follows.

# Periodic maintenance and adjustment

1. Turn the key to “OFF” and turn off the electrical circuit in question.
2. Remove the blown fuse, and then install a new fuse of the specified amperage. **WARNING! Do not use a fuse of a higher amperage rating than recommended to avoid causing extensive damage to the electrical system and possibly a fire.** [EWA15132]

## Specified fuses:

Main fuse:	30.0 A
Terminal fuse 1:	3.0 A
Headlight fuse:	7.5 A
Signaling system fuse:	7.5 A
Ignition fuse:	10.0 A
Radiator fan motor fuse:	15.0 A
ABS motor fuse:	30.0 A
ABS solenoid fuse:	20.0 A
ABS ECU fuse:	7.5 A
Fuel injection system fuse:	10.0 A
Backup fuse:	7.5 A
Accessory fuse:	10.0 A

3. Turn the key to “ON” and turn on the electrical circuit in question to check if the device operates.
4. If the fuse immediately blows again, have a Yamaha dealer check the electrical system.

## Vehicle lights

EAU80380

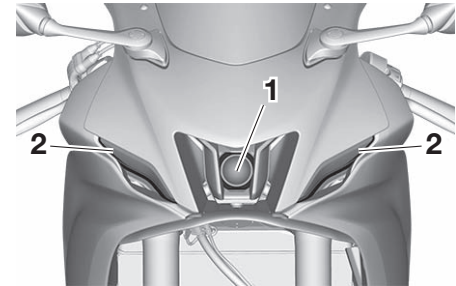

1. Headlight
2. Auxiliary light

Except for the license plate light bulb, this model’s lights are all LED. If an LED light does not come on, check the fuses and then have a Yamaha dealer check the vehicle. If the license plate light does not come on, check and replace the bulb. (See page 7-34.)

ECA16581

## **NOTICE**

**Do not affix any type of tinted film or stickers to the headlight lens.**

## Replacing a license plate light bulb

EAU49722

1. Remove the license plate light unit bolts.

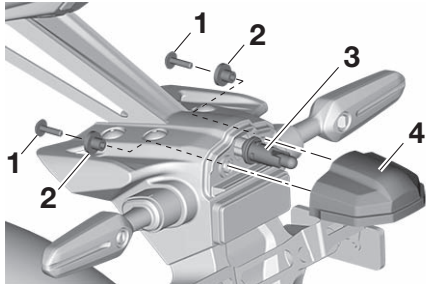

1. Bolt
2. Collar
3. License plate light bulb socket
4. License plate light unit

2. Remove the license plate light bulb socket (together with the bulb) by turning it counterclockwise, and then pulling it out.
3. Remove the burnt-out bulb by pulling it out.

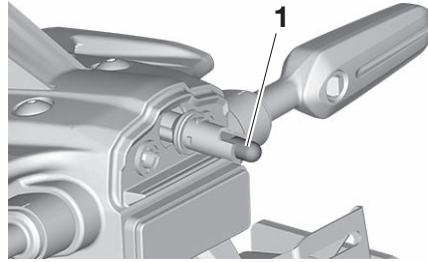

1. License plate light bulb

4. Insert a new bulb into the socket.
5. Install the socket (together with the bulb) by pushing it in, and then turning it clockwise until it stops.
6. Place the license plate light unit in the original position, and then install the bolts.

## Supporting the motorcycle

EAU67131

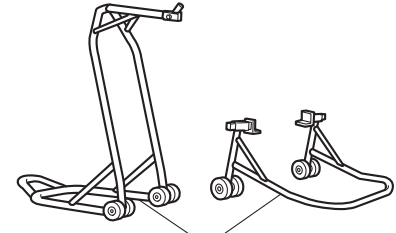

1. Maintenance stand (example)

Since this model is not equipped with a centerstand, use maintenance stands when removing the front or rear wheel or when performing other maintenance that requires the motorcycle to stand up right.

Check that the motorcycle is in a stable and level position before starting any maintenance.

# Periodic maintenance and adjustment

---

EAU25872

## Troubleshooting

Although Yamaha motorcycles receive a thorough inspection before shipment from the factory, trouble may occur during operation. Any problem in the fuel, compression, or ignition systems, for example, can cause poor starting and loss of power.

The following troubleshooting charts represent quick and easy procedures for checking these vital systems yourself. However, should your motorcycle require any repair, take it to a Yamaha dealer, whose skilled technicians have the necessary tools, experience, and know-how to service the motorcycle properly.

Use only genuine Yamaha replacement parts. Imitation parts may look like Yamaha parts, but they are often inferior, have a shorter service life and can lead to expensive repair bills.

EWA15142



**WARNING**

**When checking the fuel system, do not smoke, and make sure there are no open flames or sparks in the area, including pilot lights from water**

**heaters or furnaces. Gasoline or gasoline vapors can ignite or explode, causing severe injury or property damage.**

---



## Troubleshooting chart

### 1. Fuel

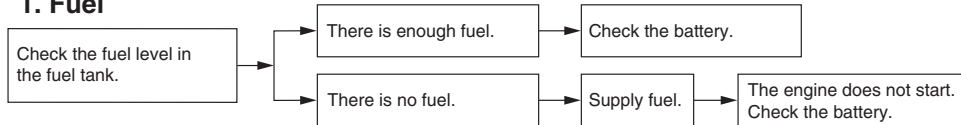

### 2. Battery

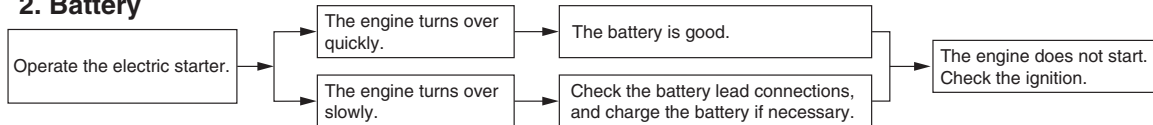

### 3. Ignition

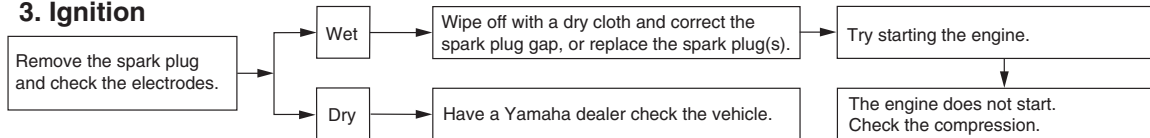

### 4. Compression

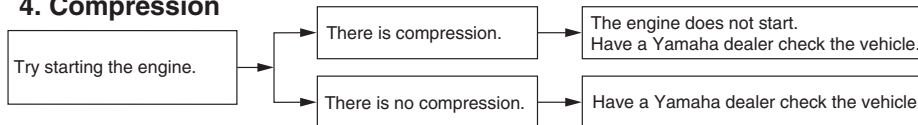

# Periodic maintenance and adjustment

EAU86420

## Engine overheating

EWAT1041

### **⚠ WARNING**

- Do not remove the radiator cap when the engine and radiator are hot. Scalding hot fluid and steam may be blown out under pressure, which could cause serious injury. Be sure to wait until the engine has cooled.
- Place a thick rag, like a towel, over the radiator cap, and then slowly rotate the cap counterclockwise to the detent to allow any residual pressure to escape. When the hissing sound has stopped, press down on the cap while turning it counterclockwise, and then remove the cap.

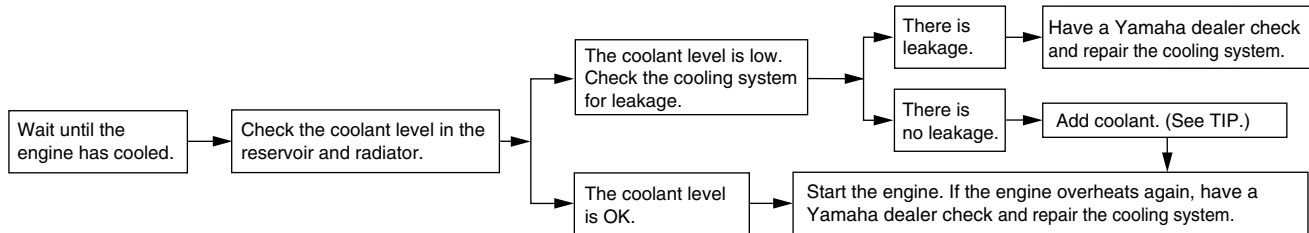

### **TIP**

If coolant is not available, tap water can be temporarily used instead, provided that it is changed to the recommended coolant as soon as possible.

## Matte color caution

EAU37834

### NOTICE

Some models are equipped with matte colored finished parts. Be sure to consult a Yamaha dealer for advice on what products to use before cleaning the vehicle. Using a brush, harsh chemical products or cleaning compounds when cleaning these parts will scratch or damage their surface. Wax also should not be applied to any matte colored finished parts.

ECA15193

## Care

EAU84992

Frequent, thorough cleaning of the vehicle will not only enhance its appearance but also will improve its general performance and extend the useful life of many components. Washing, cleaning, and polishing will also give you a chance to inspect the condition of the vehicle more frequently. Be sure to wash the vehicle after riding in the rain or near the sea, because salt is corrosive to metals.

## Special care in winter

ECA28181

### NOTICE

In cold weather, when roads may be salted as a de-icing method, it's important to clean the vehicle thoroughly to remove road salt and avoid corrosion. Wheel spokes, bolts/nuts and other unpainted metal parts can be especially vulnerable to corrosion from road salt. Apply an anti-corrosion product to any vulnerable parts after washing and drying the vehicle.

ECA26280

## TIP

- The roads of heavy snowfall areas may be sprayed with salt as a de-icing method. This salt can stay on the roads well into spring, so be sure to wash the underside and chassis parts after riding in such areas.
- Genuine Yamaha care and maintenance products are sold under the YAMALUBE brand in many markets worldwide.
- See your Yamaha dealer for additional cleaning tips.

### NOTICE

Improper cleaning can cause cosmetic and mechanical damage. Do not use:

- high-pressure washers or steam-jet cleaners. Excessive water pressure may cause water seepage and deterioration of wheel bearings, brakes, transmission seals and electrical devices. Avoid high-pressure

# Motorcycle care and storage

---

detergent applications such as those available in coin-operated car washers.

- harsh chemicals, including strong acidic wheel cleaners, especially on spoke or magnesium wheels.
- harsh chemicals, abrasive cleaning compounds, or wax on matte-finished parts. Brushes can scratch and damage the matte-finish, use soft sponge or towel only.
- towels, sponges, or brushes contaminated with abrasive cleaning products or strong chemicals such as, solvents, gasoline, rust removers, brake fluid, or antifreeze, etc.

---

## Before washing

1. Park the vehicle out of direct sunlight and allow it to cool. This will help avoid water spots.
2. Make sure all caps, covers, electrical couplers and connectors are tightly installed.
3. Cover the muffler end with a plastic bag and a strong rubber band.

4. Pre-soak stubborn stains like insects or bird droppings with a wet towel for a few minutes.
5. Remove road grime and oil stains with a quality degreasing agent and a plastic-bristle brush or sponge. **NOTICE: Do not use degreasing agent on areas requiring lubrication such as seals, gaskets, and wheel axles. Follow product instructions.**

[ECA26290]

## Washing

1. Rinse off any degreaser and spray down the vehicle with a garden hose. Use only enough pressure to do the job. Avoid spraying water directly into the muffler, instrument panel, air inlet, or other inner areas such as underseat storage compartments.
2. Wash the vehicle with a quality automotive-type detergent mixed with cool water and a soft, clean towel or sponge. Use an old toothbrush or plastic-bristle brush for hard-to-reach places. **NOTICE: Use cold water if the vehicle has**

**been exposed to salt. Warm water will increase salt's corrosive properties.** [ECA26301]

3. For windshield-equipped vehicles: Clean the windshield with a soft towel or sponge dampened with water and a pH neutral detergent. If necessary, use a high-quality windshield cleaner or polish for motorcycles. **NOTICE: Never use any strong chemicals to clean the windshield. Additionally, some cleaning compounds for plastic may scratch the windshield, so be sure to test all cleaning products before general application.** [ECA26310]
4. Rinse off thoroughly with clean water. Be sure to remove all detergent residues, as they can be harmful to plastic parts.

## After washing

1. Dry the vehicle with a chamois or absorbent towel, preferably microfiber terrycloth.
2. For drive chain-equipped models: Dry and then lubricate the drive chain to prevent rust.

3. Use a chrome polish to shine chrome, aluminum, and stainless steel parts. Often the thermally induced discoloring of stainless steel exhaust systems can be removed through polishing.
4. Apply a corrosion protection spray on all metal parts including chrome or nickel-plated surfaces. **WARNING! Do not apply silicone or oil spray to seats, hand grips, rubber foot pegs or tire treads. Otherwise these parts will become slippery, which could cause loss of control. Thoroughly clean the surfaces of these parts before operating the vehicle.** [EWA20651]
5. Treat rubber, vinyl, and unpainted plastic parts with a suitable care product.
6. Touch up minor paint damage caused by stones, etc.
7. Wax all painted surfaces using a non-abrasive wax or use a detail spray for motorcycles.

8. When finished cleaning, start the engine and let it idle for several minutes to help dry any remaining moisture.
9. If the headlight lens has fogged up, start the engine and turn on the headlight to help remove the moisture.
10. Let the vehicle dry completely before storing or covering it.

ECA26320

## NOTICE

- Do not apply wax to rubber or unpainted plastic parts.
- Do not use abrasive polishing compounds as they will wear away the paint.
- Apply sprays and wax sparingly. Wipe off excess afterwards.

EWA20660

## WARNING

**Contaminants left on the brakes or tires can cause loss of control.**

- Make sure there is no lubricant or wax on the brakes or tires.
- If necessary, wash the tires with warm water and a mild detergent.

- If necessary, clean the brake discs and pads with brake cleaner or acetone.
- Before riding at higher speeds, test the vehicle's braking performance and cornering behavior.

# Motorcycle care and storage

---

## Storage

Always store the vehicle in a cool, dry place. If necessary, protect it against dust with a porous cover. Be sure the engine and the exhaust system are cool before covering the vehicle. If the vehicle often sits for weeks at a time between uses, the use of a quality fuel stabilizer is recommended after each fill-up.

EAU83472

ECA21170

### NOTICE

- **Storing the vehicle in a poorly ventilated room or covering it with a tarp, while it is still wet, will allow water and humidity to seep in and cause rust.**
- **To prevent corrosion, avoid damp cellars, stables (because of the presence of ammonia) and areas where strong chemicals are stored.**

## Long term storage

Before storing the vehicle long term (60 days or more):

1. Make all necessary repairs and perform any outstanding maintenance.
2. Follow all instructions in the Care section of this chapter.
3. Fill up the fuel tank, adding fuel stabilizer according to product instructions. Run the engine for 5 minutes to distribute treated fuel through the fuel system.
4. For vehicles equipped with a fuel cock: Turn the fuel cock lever to the off position.
5. For vehicles with a carburetor: To prevent fuel deposits from building up, drain the fuel in the carburetor float chamber into a clean container. Retighten the drain bolt and pour the fuel back into the fuel tank.
6. Use a quality engine fogging oil according to product instructions to protect internal engine components from corrosion. If engine fogging oil is not available, perform the following steps for each cylinder:
  - a. Remove the spark plug cap and spark plug.
  - b. Pour a teaspoonful of engine oil into the spark plug bore.
  - c. Install the spark plug cap onto the spark plug, and then place the spark plug on the cylinder head so that the electrodes are grounded. (This will limit sparking during the next step.)
  - d. Turn the engine over several times with the starter. (This will coat the cylinder wall with oil.)  
**WARNING! To prevent damage or injury from sparking, make sure to ground the spark plug electrodes while turning the engine over.**
7. Lubricate all control cables, pivots, levers and pedals, as well as the sidestand and centerstand (if equipped).
8. Check and correct the tire air pressure, and then lift the vehicle so that all wheels are off the ground. Otherwise, turn the

[EWA10952]

wheels a little once a month in order to prevent the tires from becoming degraded in one spot.

9. Cover the muffler outlet with a plastic bag to prevent moisture from entering it.
10. Remove the battery and fully charge it, or attach a maintenance charger to keep the battery optimally charged. **NOTICE: Confirm that the battery and its charger are compatible. Do not charge a VRLA battery with a conventional charger.** [ECA26330]

### TIP

---

- If the battery will be removed, charge it once a month and store it in a temperate location between 0-30 °C (32-90 °F).
  - See page 7-31 for more information on charging and storing the battery.
-

# Specifications

## Dimensions:

- Overall length:  
2070 mm (81.5 in)
- Overall width:  
705 mm (27.8 in)
- Overall height:  
1160 mm (45.7 in)
- Seat height:  
835 mm (32.9 in)
- Wheelbase:  
1395 mm (54.9 in)
- Ground clearance:  
135 mm (5.31 in)
- Minimum turning radius:  
3.4 m (11.16 ft)

## Weight:

- Curb weight:  
188 kg (414 lb)

## Engine:

- Combustion cycle:  
4-stroke
- Cooling system:  
Liquid cooled
- Valve train:  
DOHC
- Cylinder arrangement:  
Inline
- Number of cylinders:  
2-cylinder
- Displacement:  
689 cm<sup>3</sup>
- Bore × stroke:  
80.0 × 68.6 mm (3.15 × 2.70 in)

- Starting system:  
Electric starter

## Engine oil:

- Recommended brand:



- SAE viscosity grades:  
10W-40
- Recommended engine oil grade:  
API service SG type or higher, JASO  
standard MA
- Engine oil quantity:  
Oil change:  
2.30 L (2.43 US qt, 2.02 Imp.qt)  
With oil filter removal:  
2.60 L (2.75 US qt, 2.29 Imp.qt)

## Coolant quantity:

- Coolant reservoir (up to the maximum level  
mark):  
0.25 L (0.26 US qt, 0.22 Imp.qt)
- Radiator (including all routes):  
1.60 L (1.69 US qt, 1.41 Imp.qt)

## Fuel:

- Recommended fuel:  
Unleaded gasoline (E10 acceptable)
- Octane number (RON):  
90
- Fuel tank capacity:  
13 L (3.4 US gal, 2.9 Imp.gal)
- Fuel reserve amount:  
2.5 L (0.66 US gal, 0.55 Imp.gal)

## Fuel injection:

- Throttle body:  
ID mark:  
1WS1

## Drivetrain:

- Gear ratio:  
1st:  
2.846 (37/13)
- 2nd:  
2.125 (34/16)
- 3rd:  
1.632 (31/19)
- 4th:  
1.300 (26/20)
- 5th:  
1.091 (24/22)
- 6th:  
0.964 (27/28)

## Front tire:

- Type:  
Tubeless
- Size:  
120/70ZR17M/C (58W)
- Manufacturer/model:  
BRIDGESTONE/BATTLAX HYPERSPORT  
S22F

## Rear tire:

- Type:  
Tubeless
- Size:  
180/55ZR17M/C (73W)
- Manufacturer/model:  
BRIDGESTONE/BATTLAX HYPERSPORT  
S22R



**Loading:**

Maximum load:

162 kg (357 lb)

(Total weight of rider, passenger, cargo and accessories)

Auxiliary light:

LED

License plate light:

5.0 W

**Front brake:**

Type:

Hydraulic dual disc brake

**Rear brake:**

Type:

Hydraulic single disc brake

**Front suspension:**

Type:

Telescopic fork

**Rear suspension:**

Type:

Swingarm (link suspension)

**Electrical system:**

System voltage:

12 V

**Battery:**

Model:

YTZ7S

Voltage, capacity:

12 V, 6.0 Ah (10 HR)

**Bulb wattage:**

Headlight:

LED

Brake/tail light:

LED

Front turn signal light:

LED

Rear turn signal light:

LED

# Consumer information

## Identification numbers

EAU53562

Record the vehicle identification number, engine serial number, and the model label information in the spaces provided below. These identification numbers are needed when registering the vehicle with the authorities in your area and when ordering spare parts from a Yamaha dealer.

VEHICLE IDENTIFICATION NUMBER:

ENGINE SERIAL NUMBER:

MODEL LABEL INFORMATION:

## Vehicle identification number

EAU26401

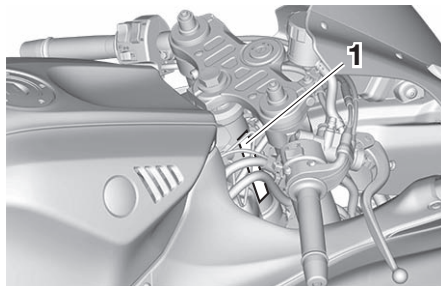

1. Vehicle identification number

The vehicle identification number is stamped into the steering head pipe. Record this number in the space provided.

### TIP

The vehicle identification number is used to identify your motorcycle and may be used to register your motorcycle with the licensing authority in your area.

## Engine serial number

EAU26442

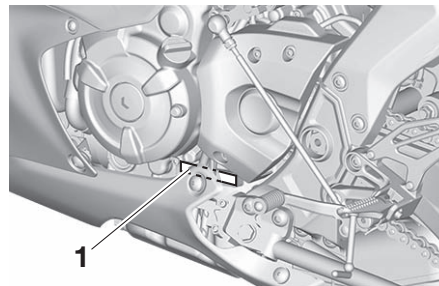

1. Engine serial number

The engine serial number is stamped into the crankcase.

## Model label

EAU26521

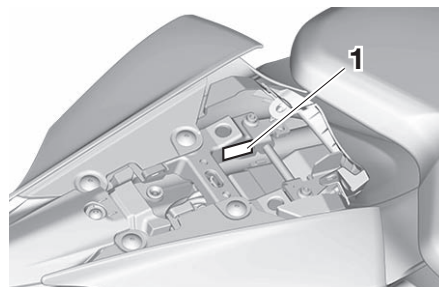

1. Model label

The model label is affixed to the frame under the passenger seat. (See page 4-18.) Record the information on this label in the space provided. This information will be needed when ordering spare parts from a Yamaha dealer.

## Diagnostic connector

EAU69910

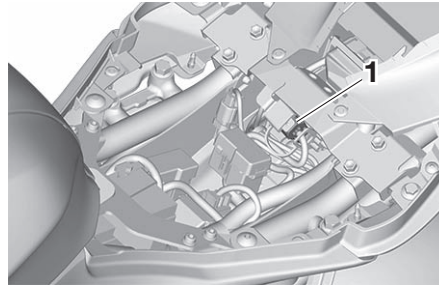

1. Diagnostic connector

The diagnostic connector is located as shown.

# Consumer information

---

EAU1020

## Use of your data

This is a brief summary of how Yamaha (Yamaha Motor Co. Ltd., and the local subsidiaries) uses your data. For more details for Yamaha's use of your data, please see our Privacy Policy.

<https://global.yamaha-motor.com/en/privacy/>

## What data we collect? and How we collect your data?

This vehicle collects three types of data through integrated Engine Control Units (ECU):

(1) Vehicle Identification Number (VIN); (2) live data showing the performance of the vehicle such as engine/motor operating state, vehicle speed, mileage; and (3) other data showing the status of the vehicle such as diagnostic trouble code (DTC). The collected data will be uploaded to server at Yamaha Motor Co., Ltd. by attaching a special Yamaha diagnostic tool to the vehicle, only when maintenance checks or service procedures are performed.

## How will we use your data?

Yamaha use collected data from your vehicle, (1) to conduct adequate maintenance service including diagnostics, (2) to implement proper warranty claim judgement, (3) to conduct research and development of vehicle, (4) to provide and improve quality of products, features, and services, (5) to ensure our business purpose, and (6) to comply with requirements of laws and regulations.

## How we share your data?

We may share your data with: (i) our subsidiaries, affiliates, and business partners; (ii) dealers and distributors in your country or region, and (iii) contractors within the scope necessary to achieve the purpose of use described above.

## How to contact us

Any questions or complaints regarding the processing of your Personal Data can be submitted in writing to the local subsidiaries.

<https://global.yamaha-motor.com/link/>

## Consumer information

---

The **SOLE PURPOSE** of above provided contact information is **TO RESPOND DATA PROCESSING INQUIRY AND OTHER KINDS OF INQUIRIES WILL NOT BE RESPONDED**. Please provide the following information for the proper handling of your inquiry: **(1) Your Name; (2) Your Email Address; (3) Your Country of Residence; and (4) Your VIN**. We will use your personal information provided only for the purpose of supporting your data processing inquiry.

# Index

## A

- ABS .....4-14
- ABS warning light .....4-4
- Air filter element and check hose, replacing and cleaning .....7-16
- Air temperature display.....4-9

## B

- Battery .....7-31
- Brake and clutch levers, checking and lubricating.....7-28
- Brake and shift pedals, checking and lubricating.....7-27
- Brake fluid, changing .....7-24
- Brake fluid level, checking .....7-22
- Brake lever .....4-14
- Brake lever free play, checking.....7-21
- Brake light switches.....7-21
- Brake pedal.....4-14

## C

- Cables, checking and lubricating .....7-26
- Canister.....7-11
- Care .....8-1
- Catalytic converter.....4-18
- Clock.....4-6
- Clutch lever .....4-13
- Clutch lever free play, adjusting .....7-20
- Coolant .....7-14
- Coolant temperature display .....4-9
- Coolant temperature warning light .....4-4
- Cowlings, removing and installing .....7-9

## D

- DC connectors.....4-25
- Diagnostic connector.....10-2
- Dimmer switch .....4-12

- Display brightness and shift timing indicator light settings mode.....4-10
- Display units, switching.....4-5
- Drive chain, cleaning and lubricating ...7-26
- Drive chain slack .....7-24

## E

- Engine break-in .....6-1
- Engine idling speed, checking .....7-16
- Engine oil and oil filter cartridge.....7-11
- Engine overheating.....7-37
- Engine serial number.....10-1
- Engine stop switch .....4-12
- Engine trouble warning light.....4-4

## F

- Front and rear brake pads, checking ...7-22
- Front fork, adjusting .....4-21
- Front fork, checking .....7-29
- Fuel.....4-16
- Fuel consumption, tips for reducing .....6-4
- Fuel meter .....4-6
- Fuel tank cap.....4-15
- Fuel tank overflow hose .....4-17
- Fuses, replacing .....7-32

## H

- Handlebar switches.....4-11
- Hazard switch.....4-12
- Helmets .....2-5
- High beam indicator light .....4-3
- Horn switch .....4-12

## I

- Identification numbers.....10-1
- Ignition circuit cut-off system.....4-26
- Immobilizer system .....4-1
- Immobilizer system indicator light.....4-4

- Indicator lights and warning lights .....4-3

## L

- Labels, location.....1-1
- License plate light bulb, replacing .....7-34

## M

- Main switch/steering lock .....4-2
- Maintenance and lubrication, periodic....7-5
- Maintenance, emission control system .....7-3
- Matte color, caution .....8-1
- Model label .....10-1
- Multi-function display .....4-7
- Multi-function meter unit.....4-5

## N

- Neutral indicator light.....4-3

## O

- Oil pressure warning light .....4-3

## P

- Parking.....6-5
- Part locations .....3-1
- Pass switch .....4-12

## Q

- Quick shifter indicator .....4-7

## R

- Rear suspension, lubricating .....7-29
- Rear view mirrors .....4-20

## S

- Safety information.....2-1
- Seats .....4-18
- SEL/RES switch .....4-13
- Shift indicator light .....4-4
- Shifting.....6-3
- Shift pedal.....4-13
- Shock absorber assembly, adjusting....4-23

Sidestand ..... 4-25  
Sidestand, checking and lubricating .... 7-28  
Spark plugs, checking ..... 7-10  
Specifications ..... 9-1  
Speedometer ..... 4-6  
Starting the engine ..... 6-2  
Start switch ..... 4-12  
Steering, checking ..... 7-30  
Storage ..... 8-4  
Supporting the motorcycle ..... 7-34  
Swingarm pivots, lubricating ..... 7-29

## T

Tachometer ..... 4-6  
Throttle grip and cable, checking and  
lubricating ..... 7-27  
Throttle grip free play, checking ..... 7-17  
Tires ..... 7-17  
Tool kits ..... 7-2  
Transmission gear display ..... 4-7  
Troubleshooting ..... 7-35  
Troubleshooting chart ..... 7-36  
Turn signal indicator lights ..... 4-3  
Turn signal switch ..... 4-12

## U

Use, your vehicle data ..... 10-3

## V

Valve clearance ..... 7-17  
Vehicle identification number ..... 10-1  
Vehicle lights ..... 7-33

## W

Wheel bearings, checking ..... 7-30  
Wheels ..... 7-20

## Y

Yamalube ..... 7-14









PRINTED IN JAPAN  
2023.09-0.3×1 CR (E)